

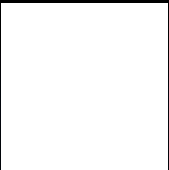

MARVEL STUDIOS
THE
INFINITY
SAGA

Booklet available in English on
Livret disponible en français sur
Folleto disponible en español en





BUILDING IS A SUPERPOWER!

Forging with LEGO® bricks is a type of forging that you can do in your living room! If you can build it, then you are truly worthy. The hammer comes with three extra hidden treasures inside and a stand with translucent blue bricks to resemble lightning crackling underneath it. Please be warned that if you throw it, it's not likely to return to your hand (in one piece), but rebuilding might just be an even bigger superpower...

Jesper C. Nielsen
Creative Lead

LA CONSTRUCTION EST UN SUPERPOUVOIR !

Vous pouvez forger avec des briques LEGO® dans le confort de votre salon ! Si vous pouvez le construire, vous êtes digne de le brandir. Le marteau comprend trois trésors cachés à l'intérieur et un support avec des briques bleues translucides pour rappeler des éclairs crépitants. Si vous le lancez, il est peu probable qu'il revienne dans votre main (en un seul morceau), mais le reconstruire pourrait être un superpouvoir encore plus grand...

Jesper C. Nielsen
Responsable de la création

¡CONSTRUIR ES UN SUPERPODER!

¡Crear objetos con bricks LEGO® es un tipo de forja que puedes hacer en tu propia sala! Si puedes construirlo, entonces eres verdaderamente digno de ello. El martillo incluye tres tesoros ocultos en su interior y un soporte que integra bricks azules translúcidos a modo de rayos que crepitan debajo. Ya te adelantamos que, si lo lanzas, no es probable que vuelva a tu mano (de una pieza), pero reconstruirlo puede concederte un superpoder aún mayor...

Jesper C. Nielsen
Director creativo

**"WHOSOEVER HOLDS THIS HAMMER, IF HE BE WORTHY,
SHALL POSSESS THE POWER OF THOR." – ODIN**

Forged from the heart of a dying star by the Dwarves for the Asgardian Royal Family, Mjöllnir, the enchanted war-hammer, is a weapon of great power. Along with giving the wielder of the hammer incredible strength and durability, Mjöllnir can also manipulate lightning by either channeling its own electricity or drawing the power of the lightning from the surrounding environment. In a world of many, few people have been worthy enough to wield, or even lift, the hammer. For a short period of time, when he was exiled to Earth as a mortal by Odin, even Thor couldn't lift Mjöllnir! Will you be among the chosen, worthy few?

**« QUICONQUE POSSÉDERA CE MARTEAU, S'IL S'EN
TROUVE DIGNE, RECEVRA LE POUVOIR DE THOR. » – ODIN**

Forgé au cœur d'une étoile mourante par les nains pour la famille royale asgardienne, Mjöllnir, le marteau de guerre enchanté, est une arme d'une grande puissance. En plus de conférer à son porteur une force et une robustesse incroyables, Mjöllnir peut également manipuler la foudre en canalisant sa propre électricité ou en puisant la puissance de la foudre dans l'environnement. Peu de gens se sont avérés dignes de manier, ou même de soulever, le marteau. Pendant une brève période, alors qu'il est exilé sur Terre en tant que mortel par Odin, même Thor ne peut pas soulever Mjöllnir ! Serez-vous parmi les quelques élus dignes de le manier ?



**"QUIEN OBTENGA ESTE MARTILLO, SI ES DIGNO DE ÉL,
POSEERÁ EL PODER DE THOR". – ODÍN**

Forjado a partir del corazón de una estrella moribunda por los enanos de la familia real Asgardiana, el martillo de guerra encantado Mjöllnir es un arma de gran poder. Además de otorgarle a su portador una fuerza y una resistencia increíbles, el Mjöllnir también puede manipular los rayos, ya sea canalizando su propia electricidad o concentrando el poder de los rayos de su entorno. En un mundo de muchos, pocas personas han sido lo suficientemente dignas como para empuñar el martillo, o siquiera levantarlo. Durante un breve período de tiempo, cuando fue exiliado a la Tierra como mortal por Odín, ¡ni siquiera Thor fue capaz de levantar el Mjöllnir! ¿Estarás tú entre los pocos y dignos elegidos?

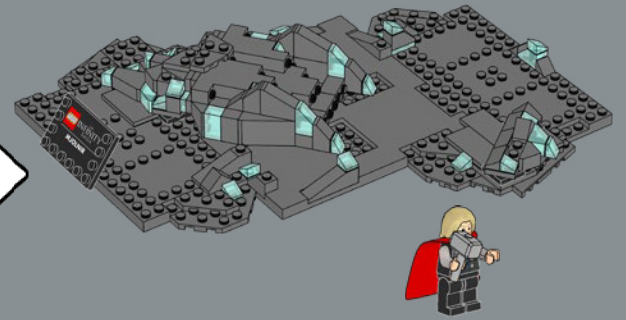
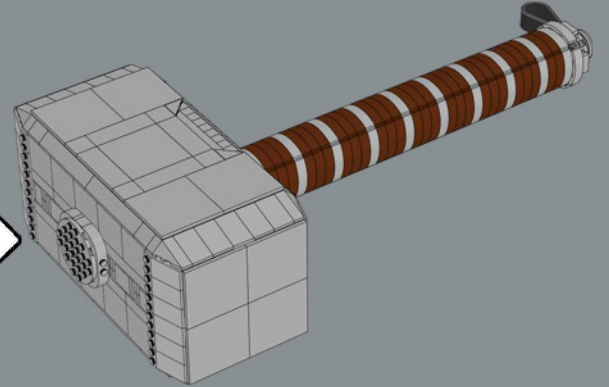
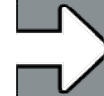
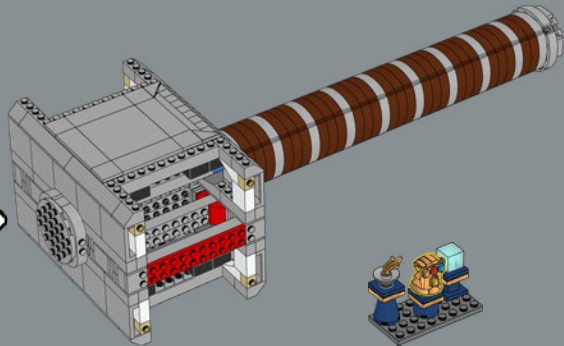
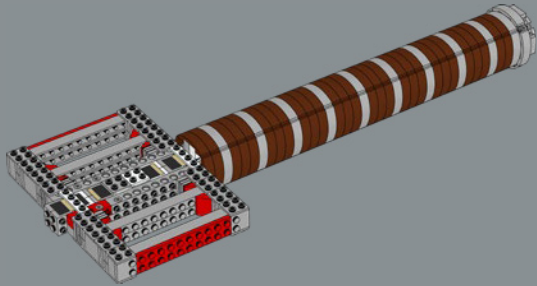
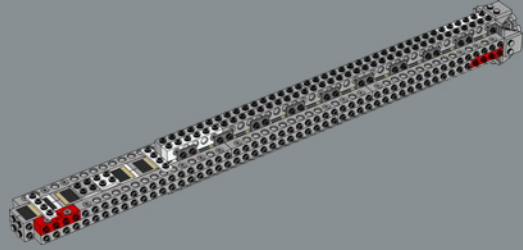

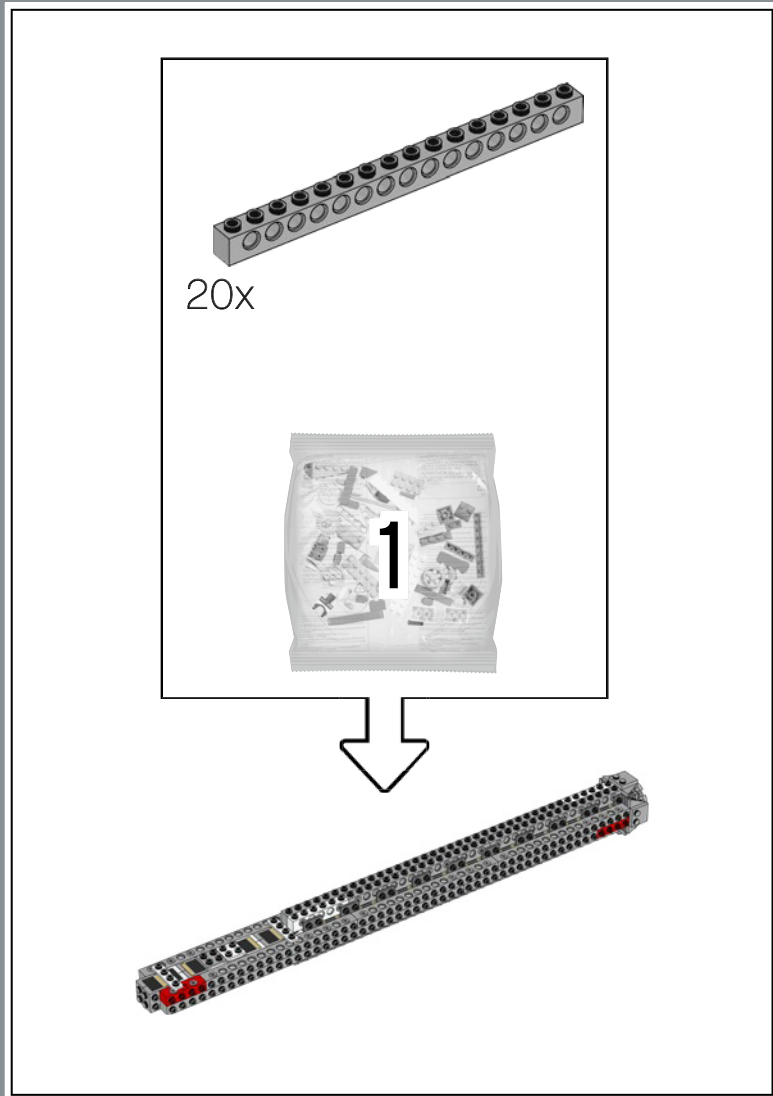

1

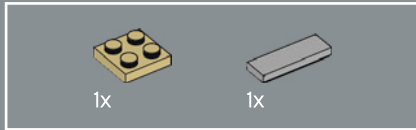
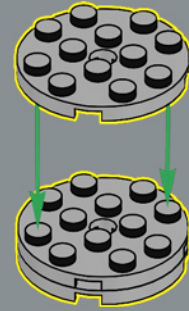

2

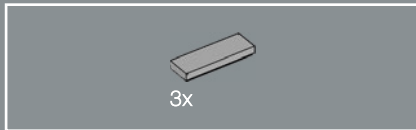
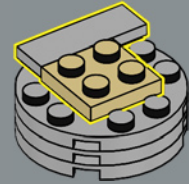

3

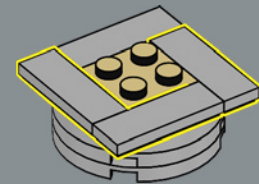

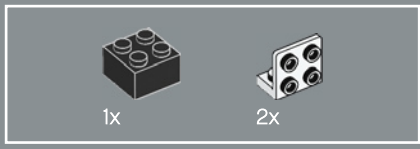

4

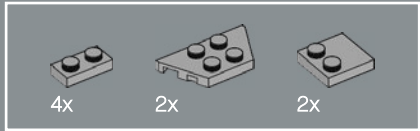
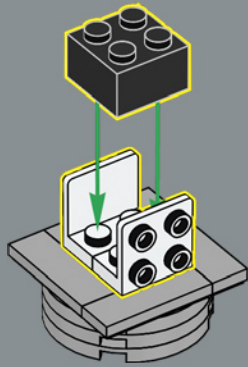

5

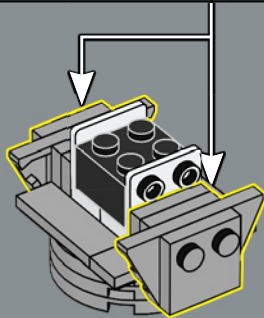
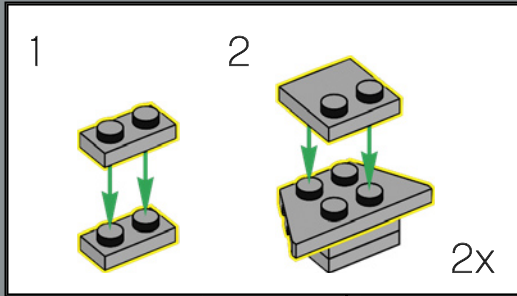

6

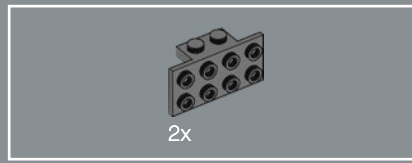

6

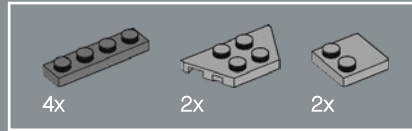
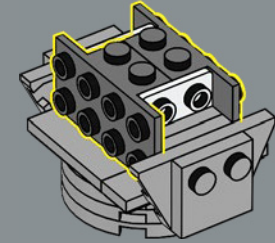

7

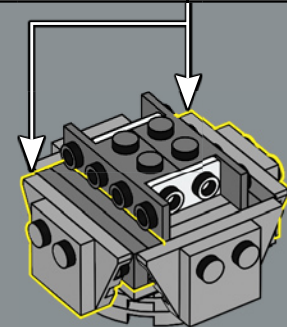
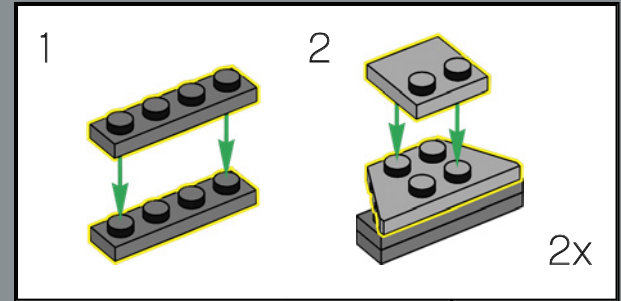

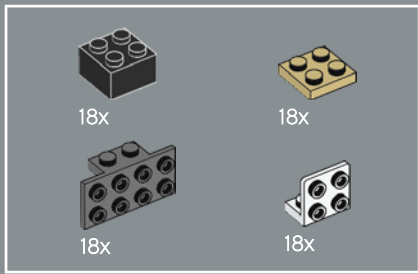

8

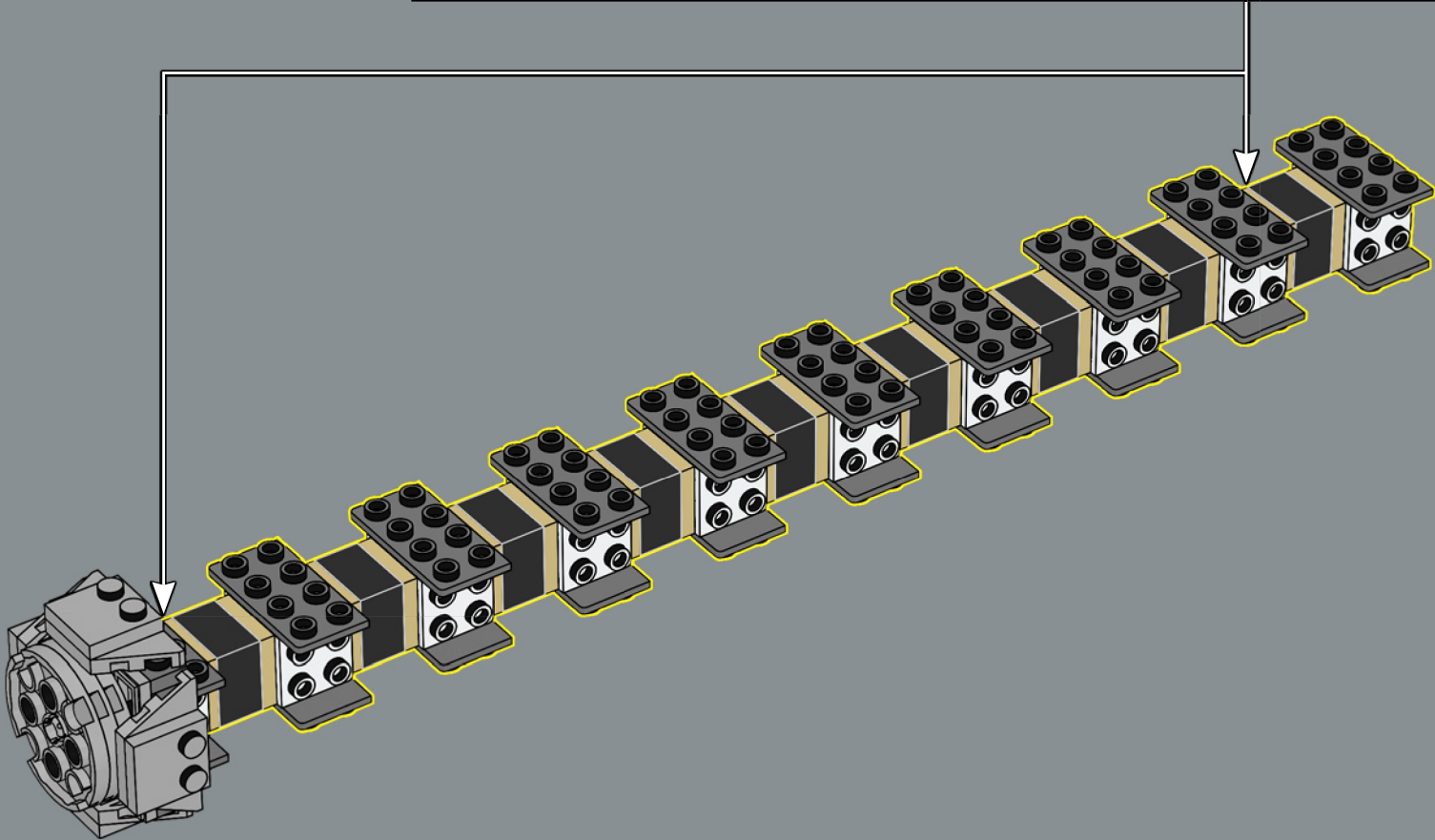
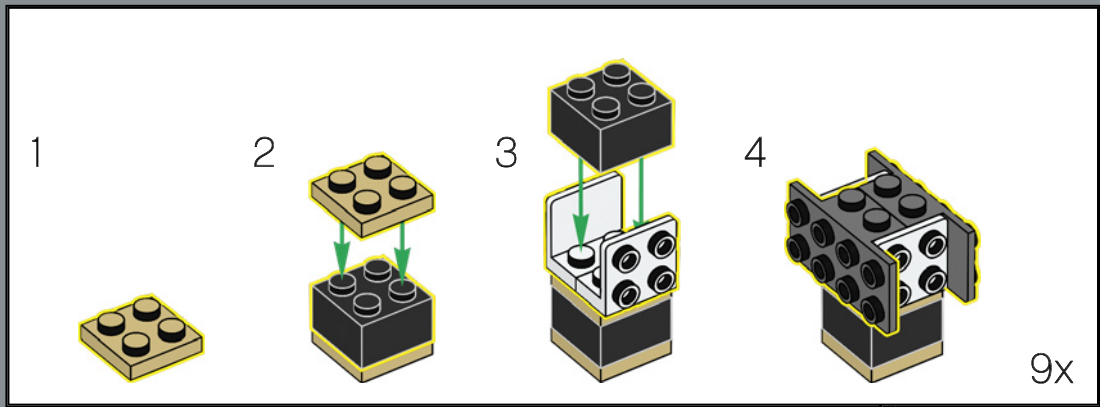

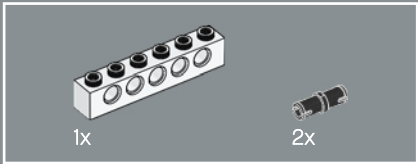
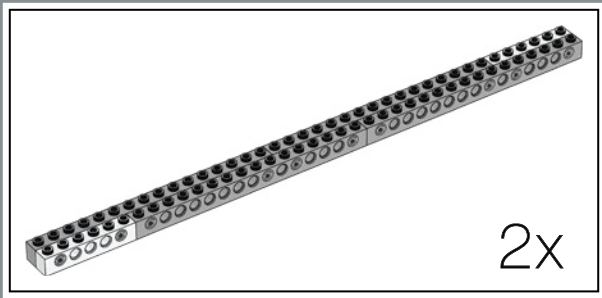

9

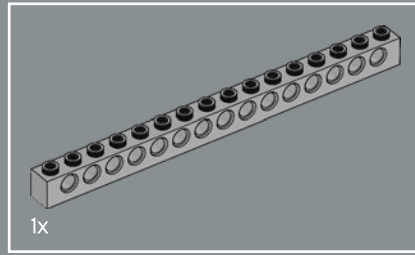
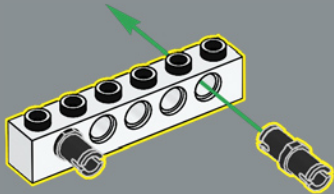

10

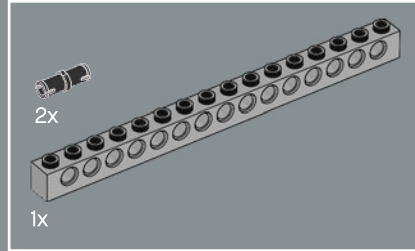
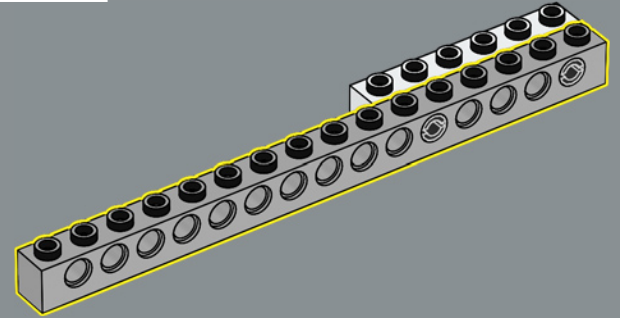

11

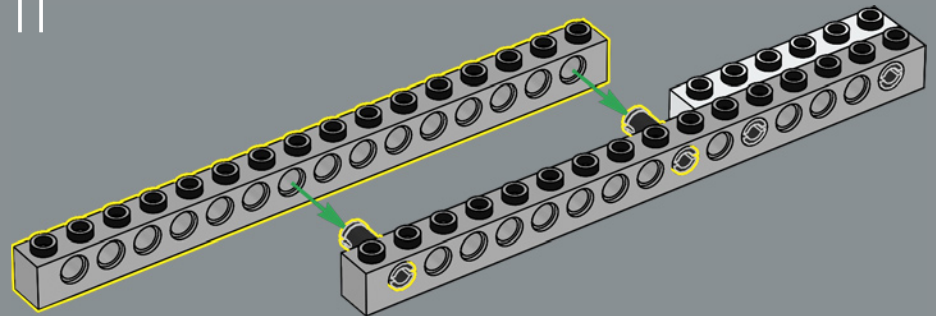

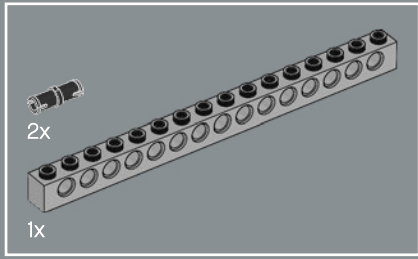

12

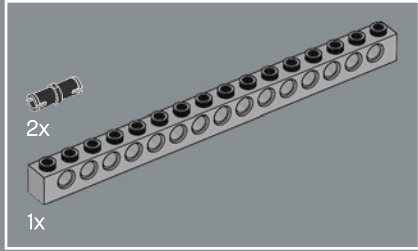
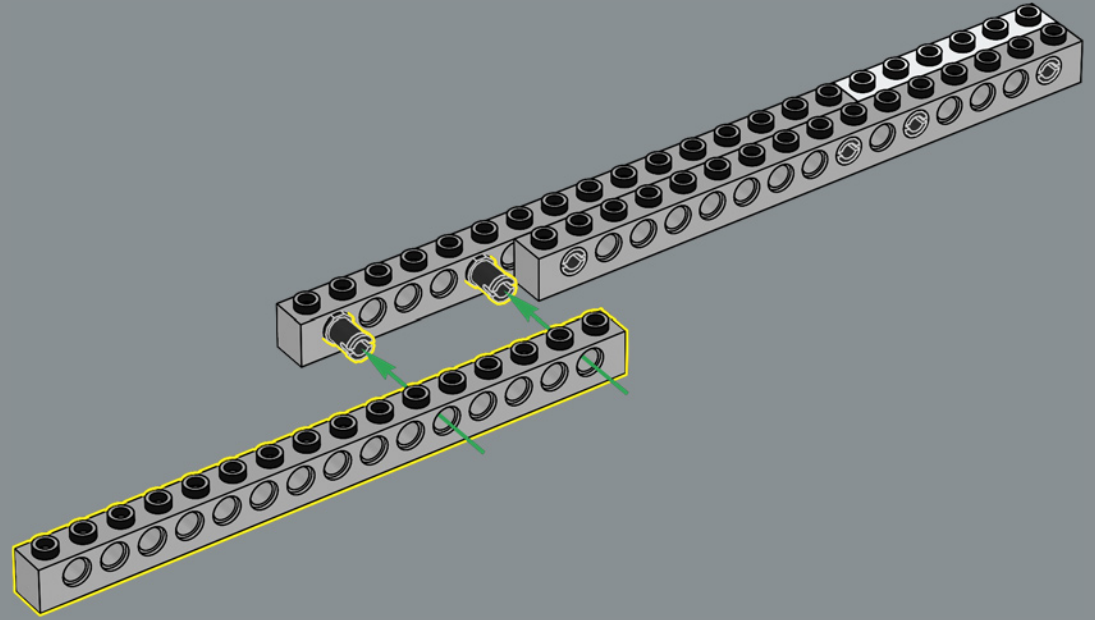

13

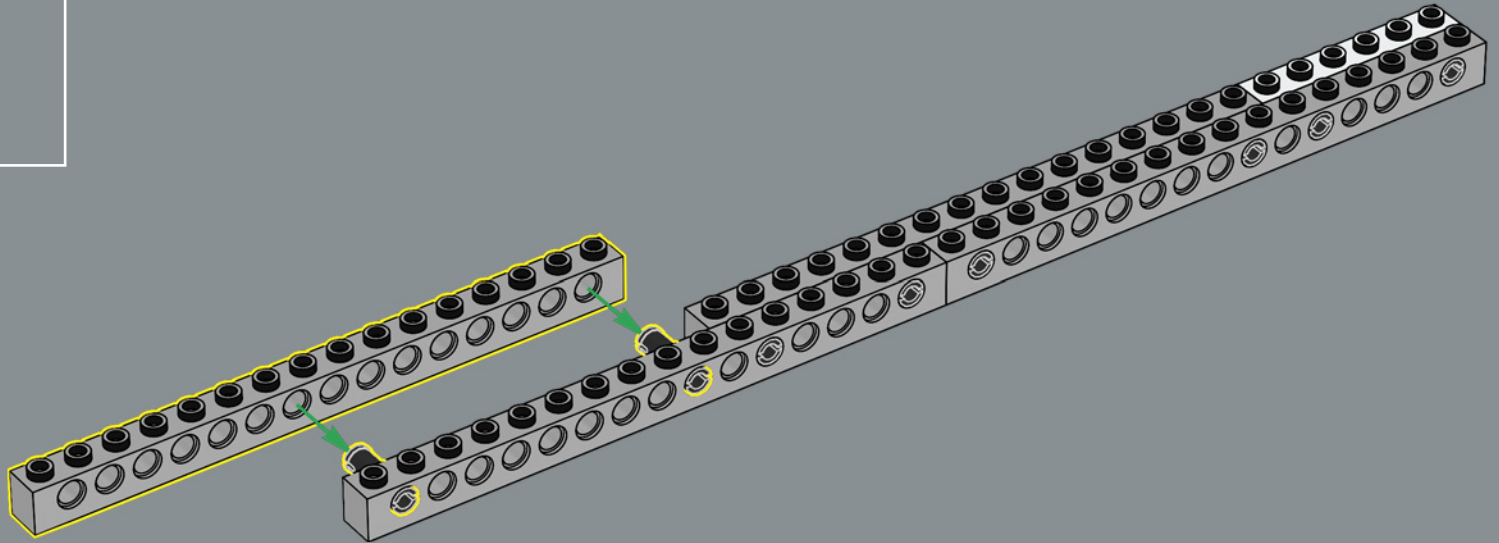

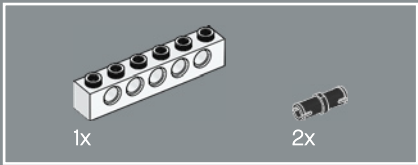

14

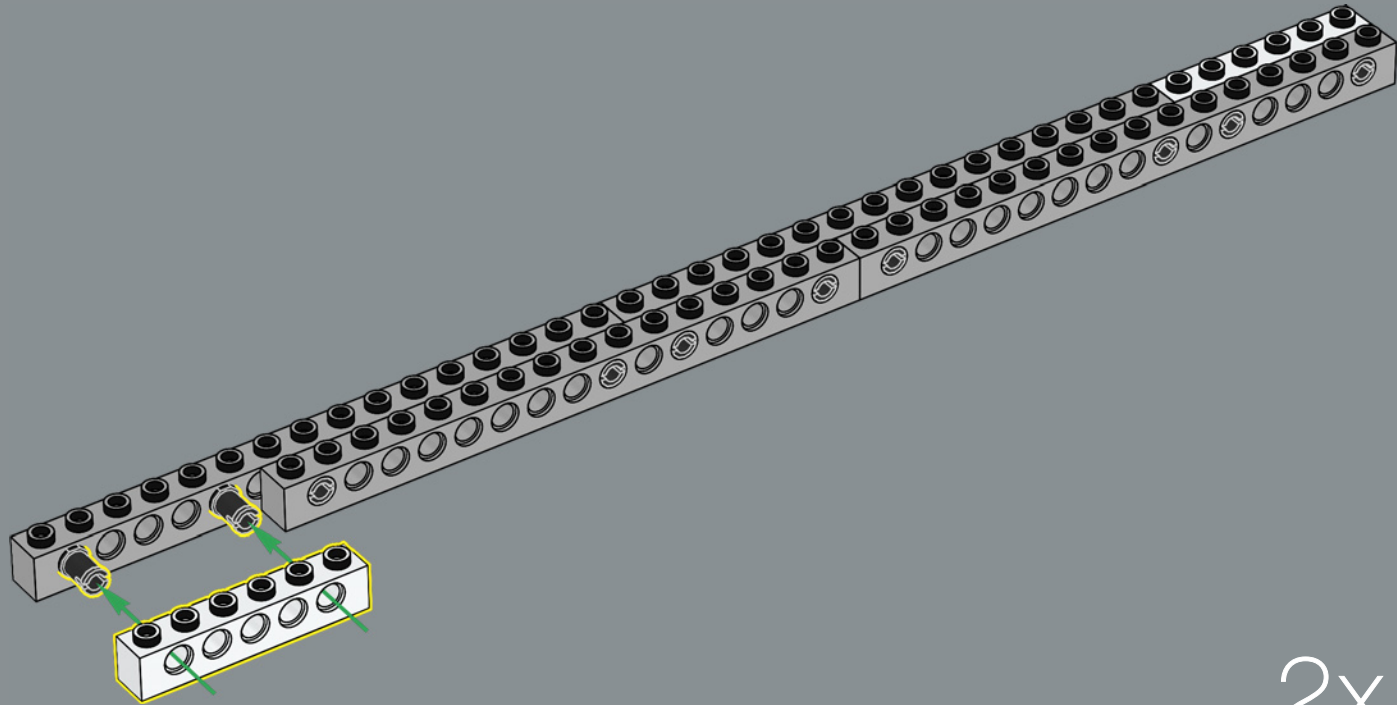

15

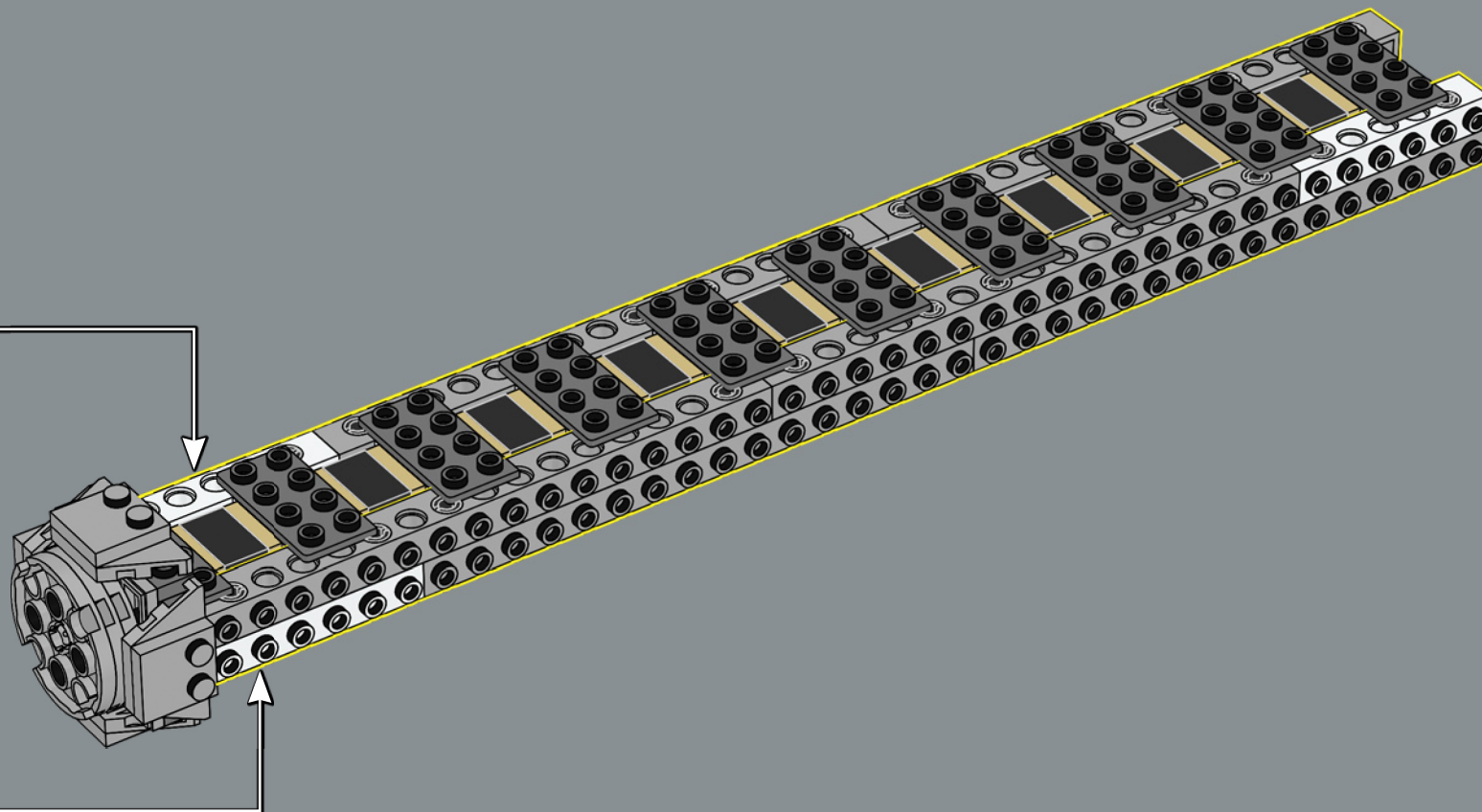

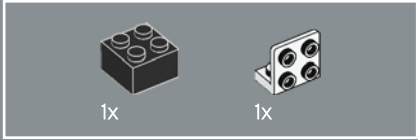
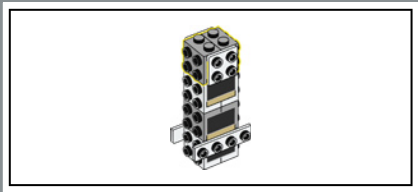

16

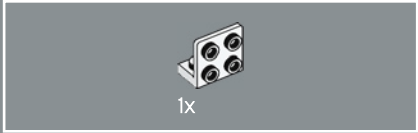
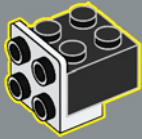

17

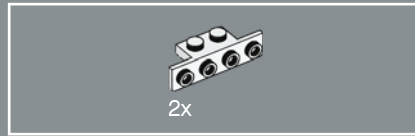

18

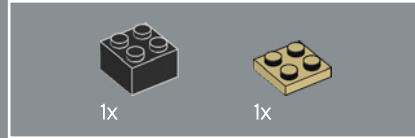
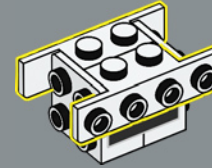

19

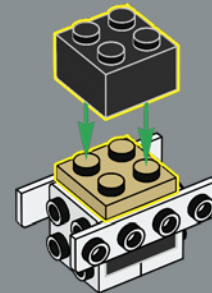



20

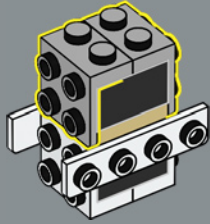

21

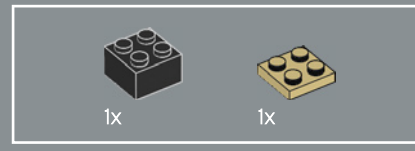
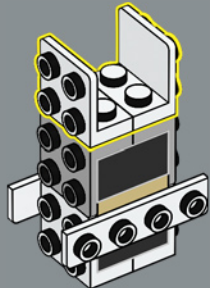

22

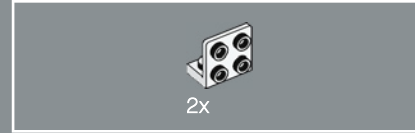
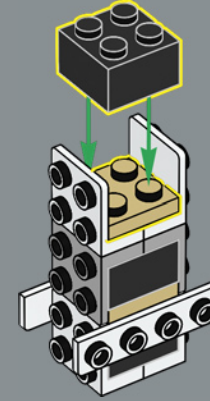

23

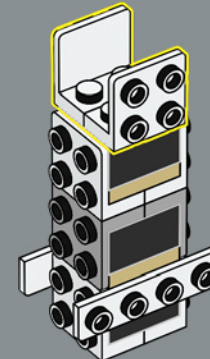



1x

24

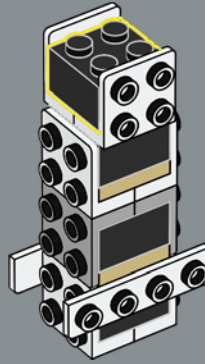

2x

25

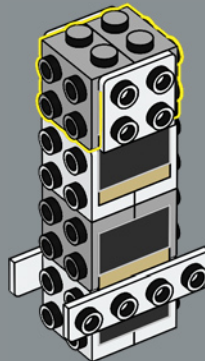

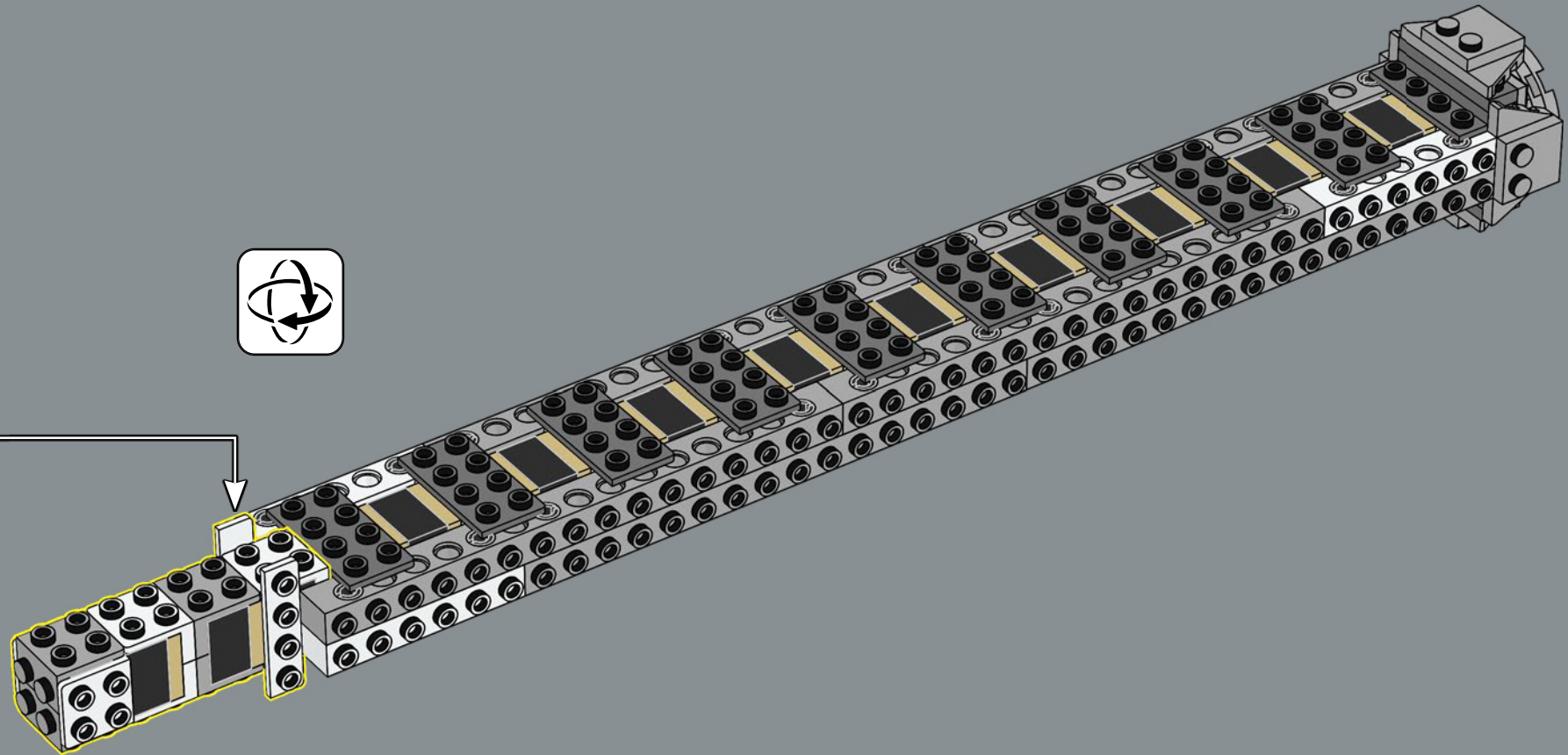

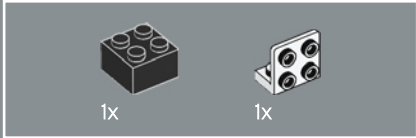
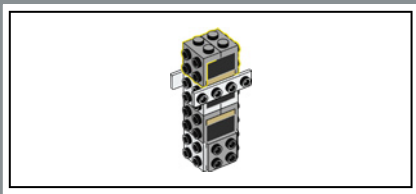

27

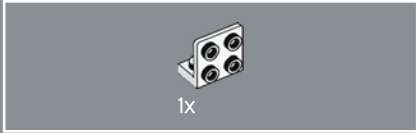
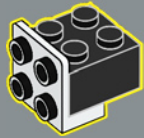

28

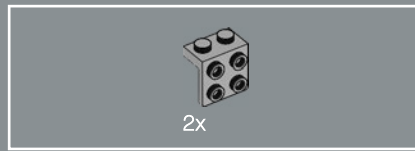
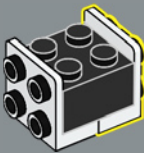

29

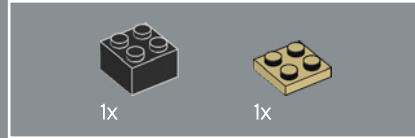
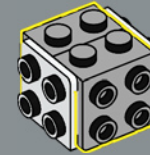

30

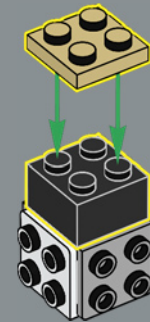



31

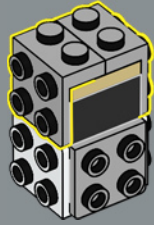

32

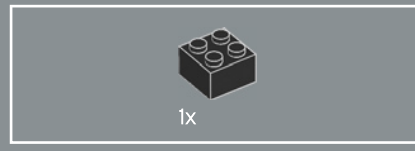
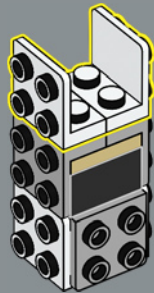

33

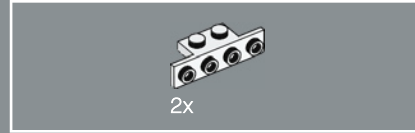
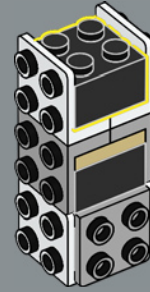

34

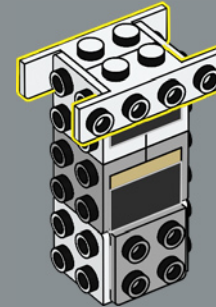

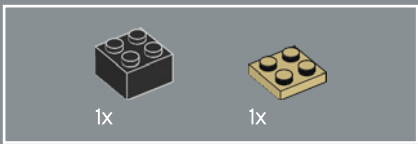

35

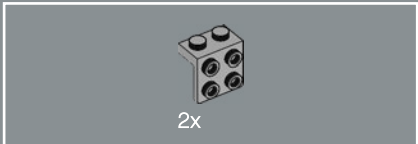
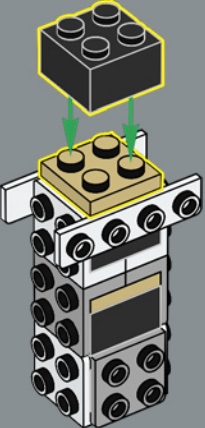

36

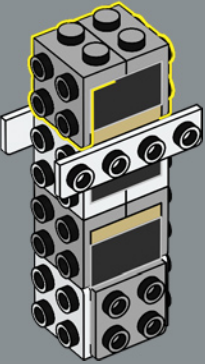

37

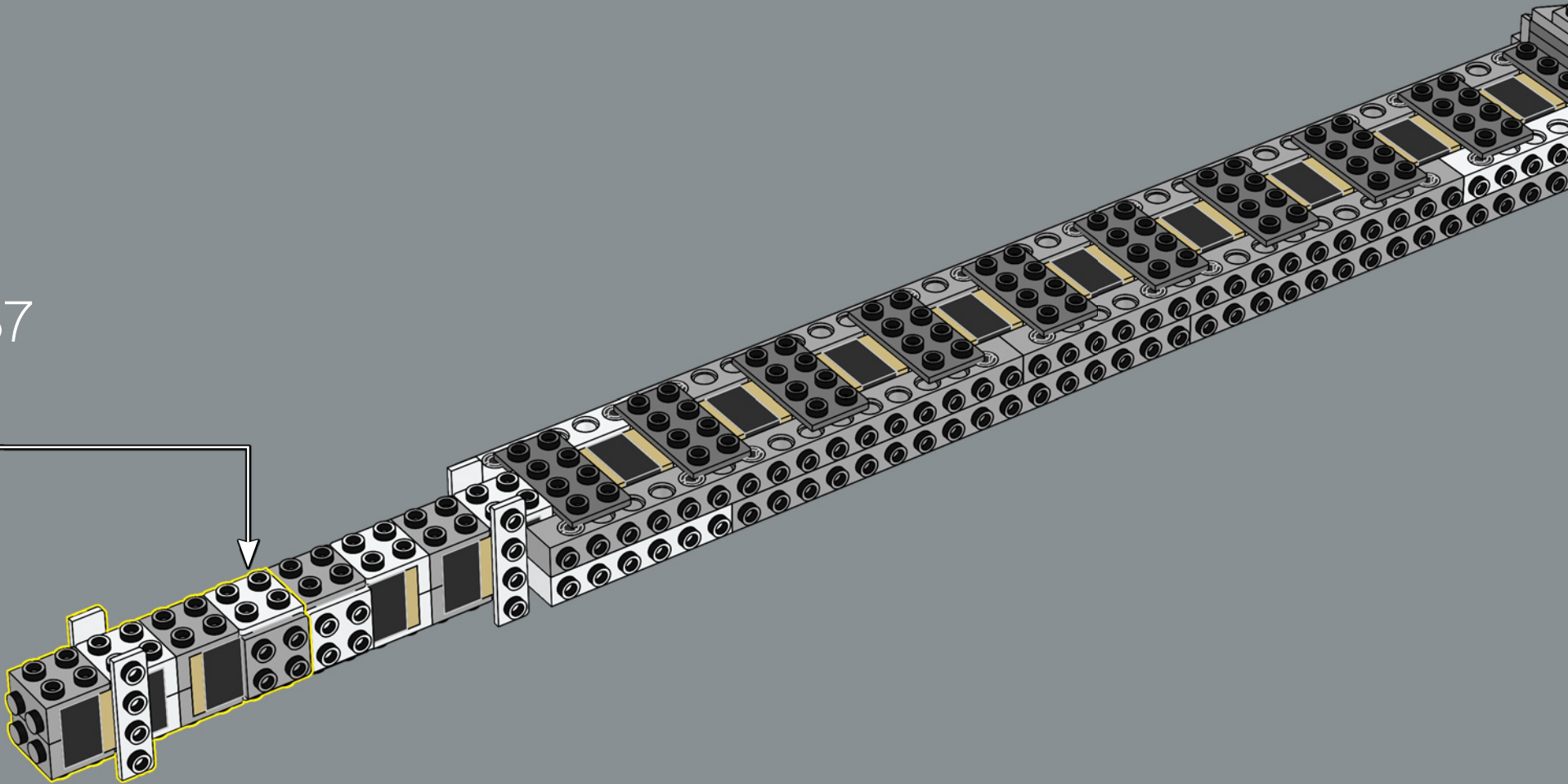

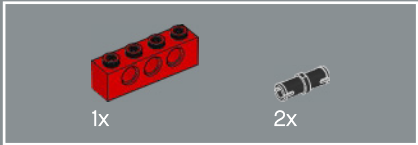
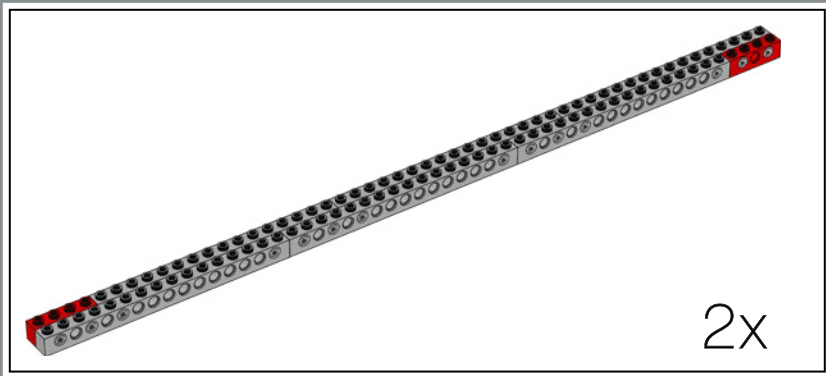

38

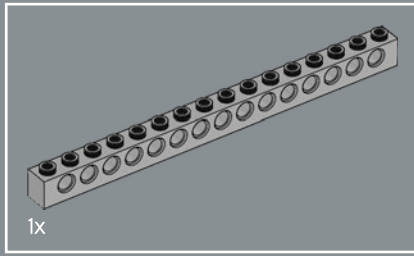
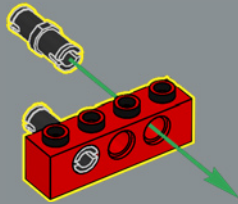

39

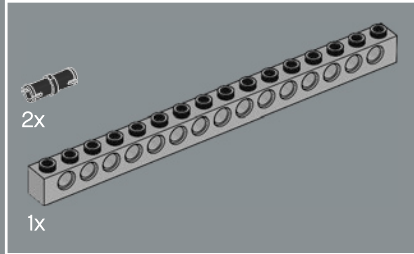
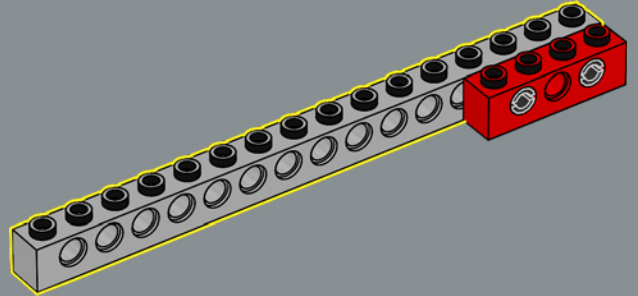

40

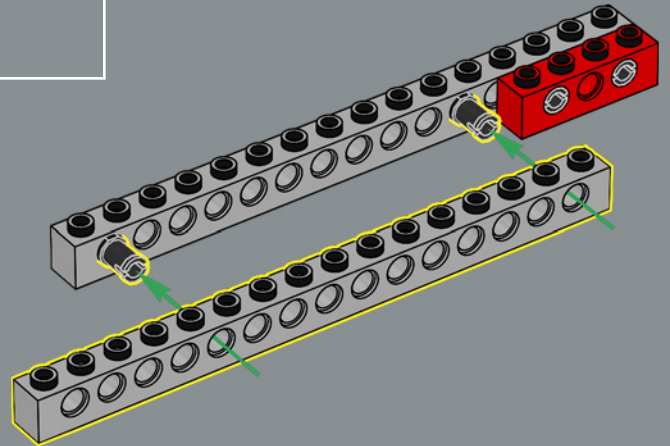

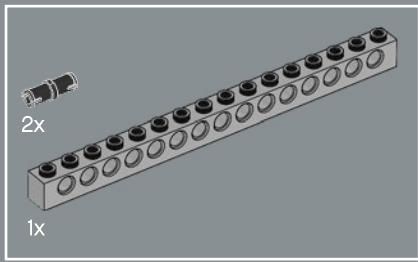

41

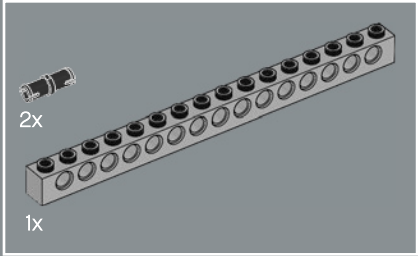
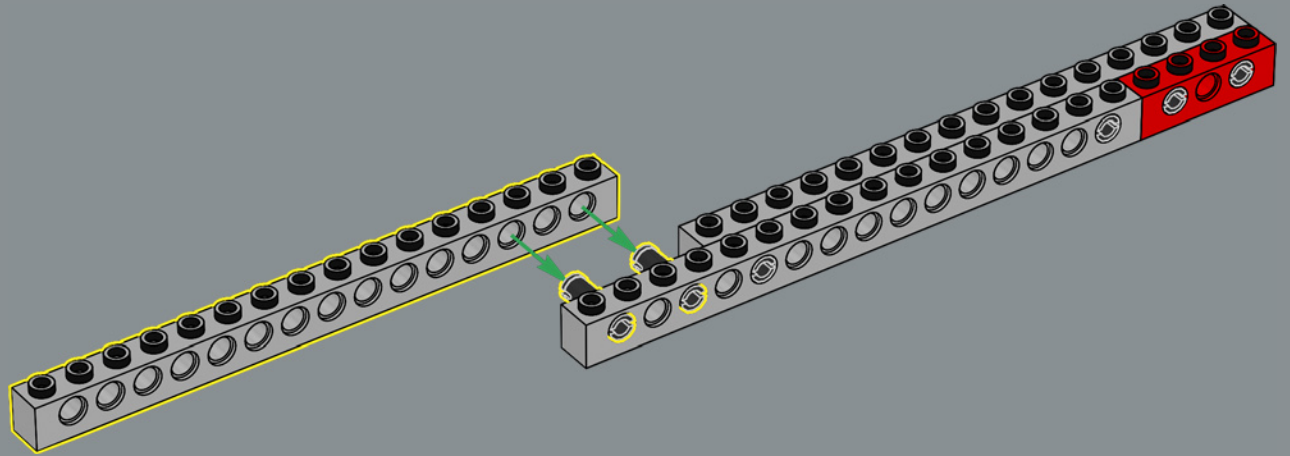

42

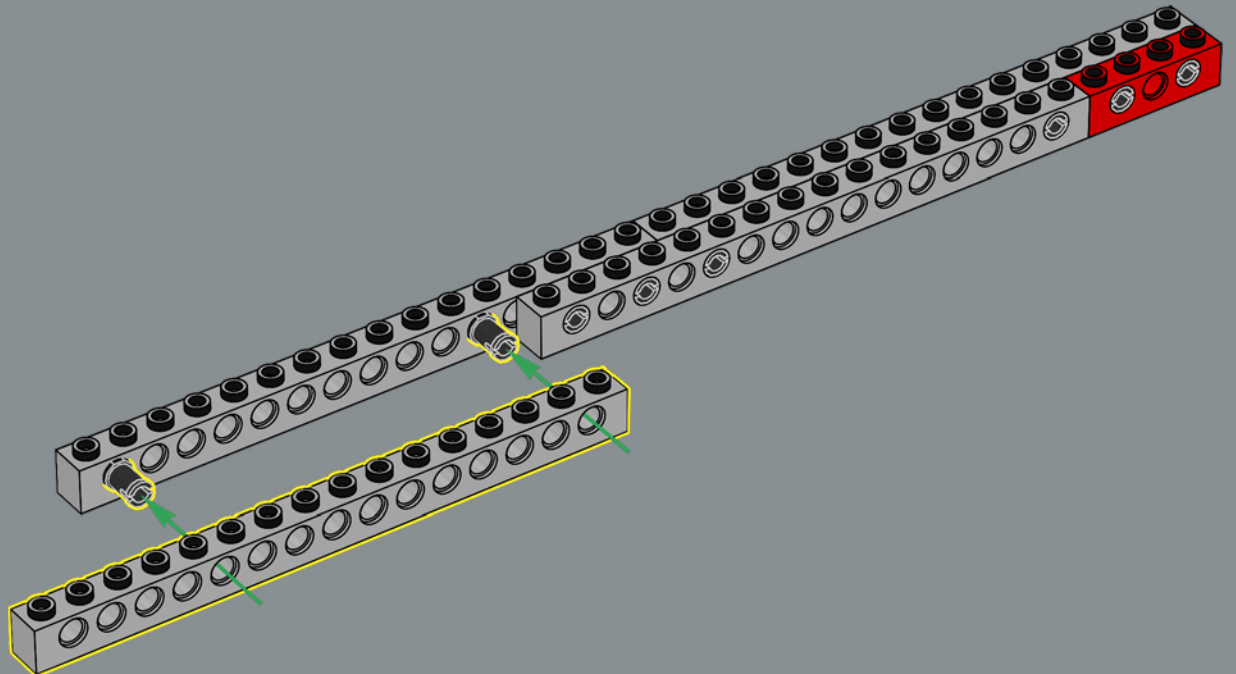

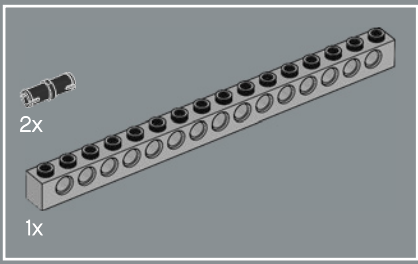

43

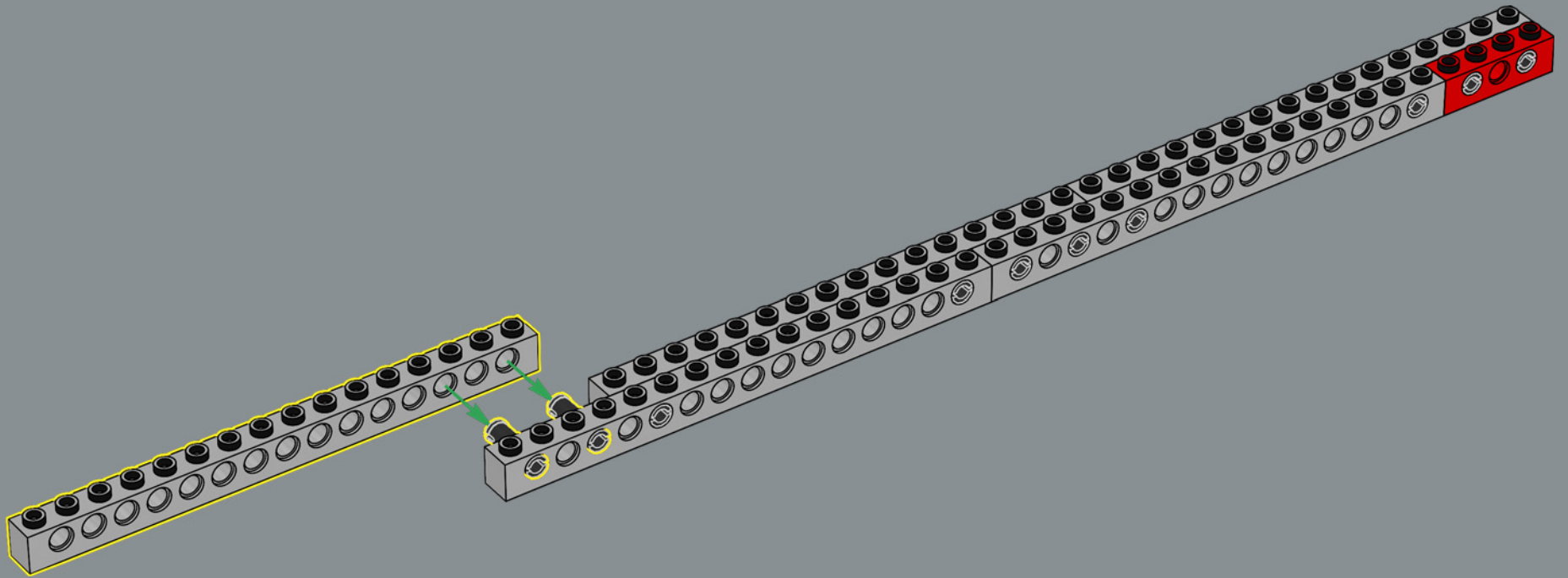

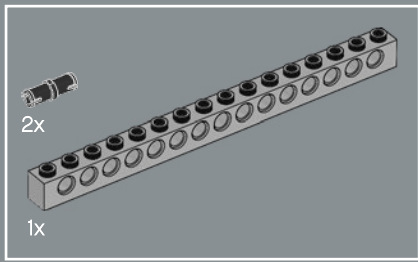

44

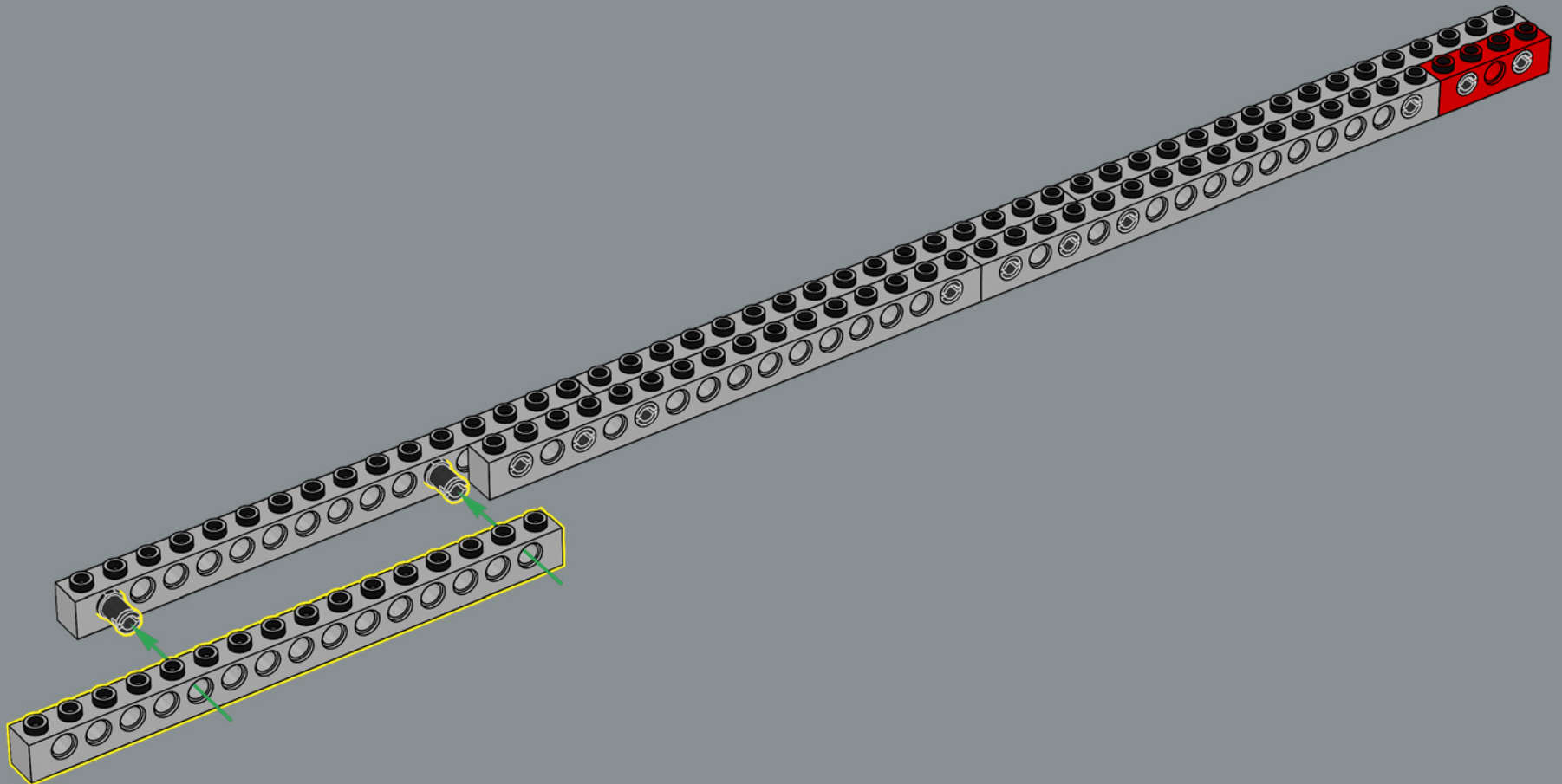

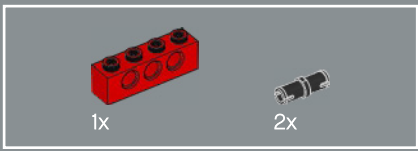

45

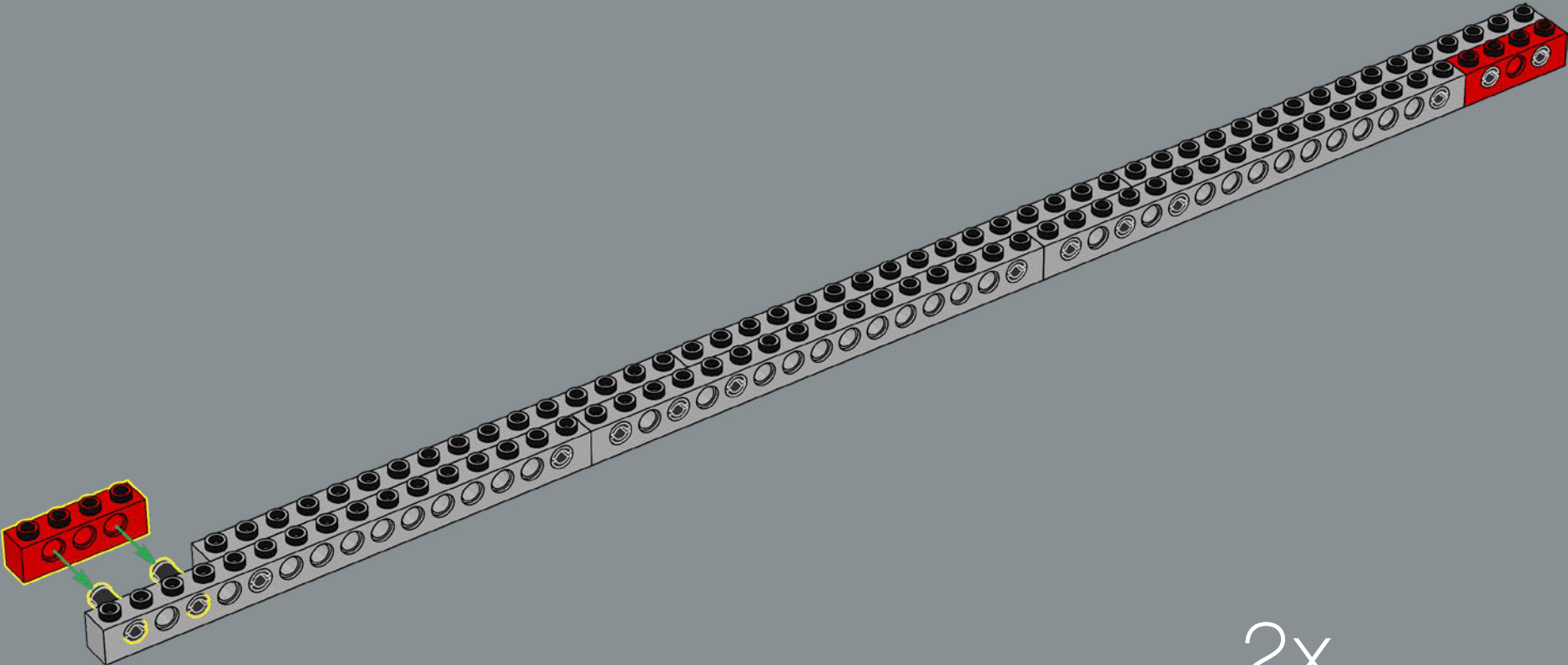

46

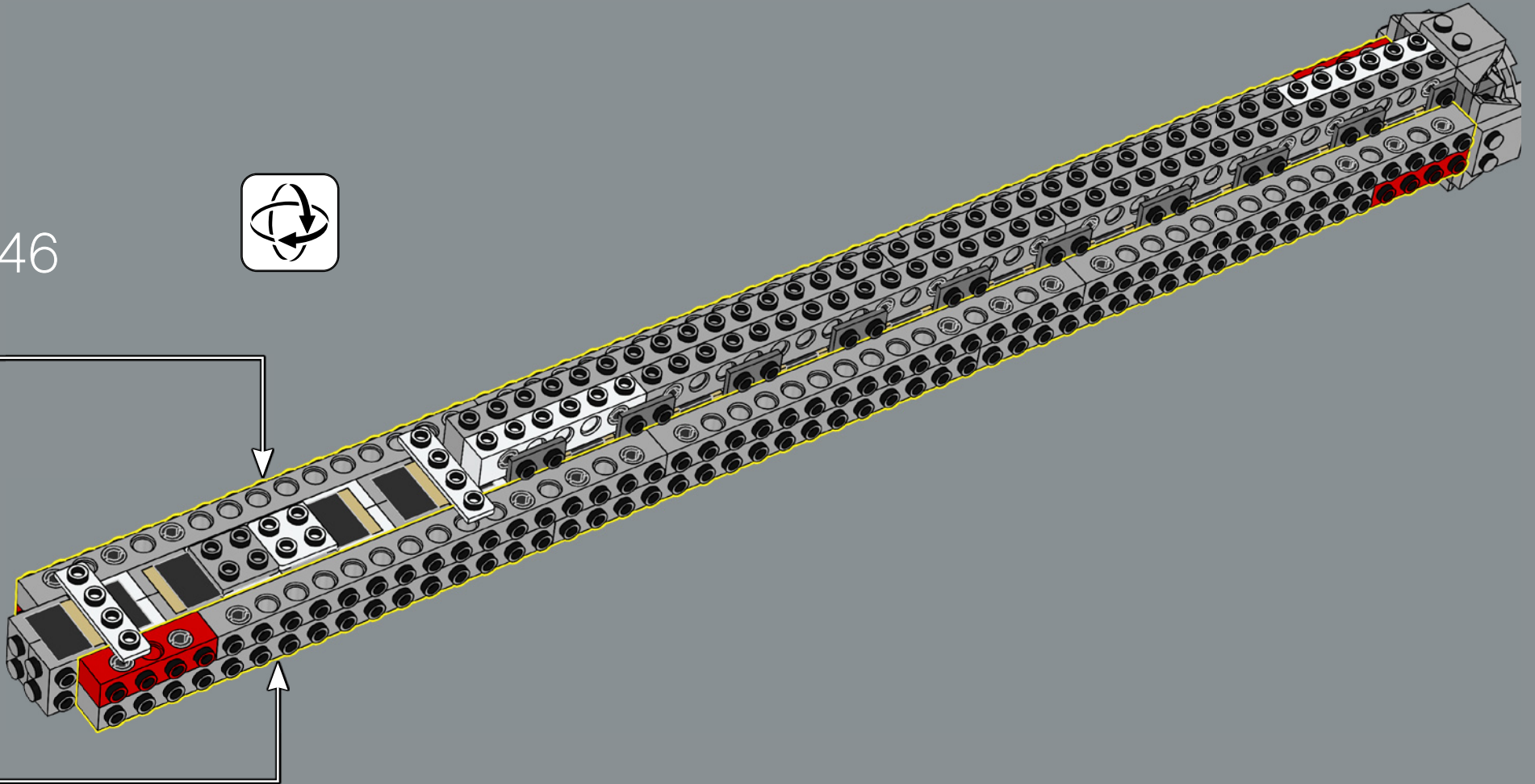

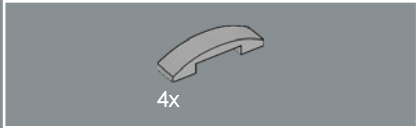
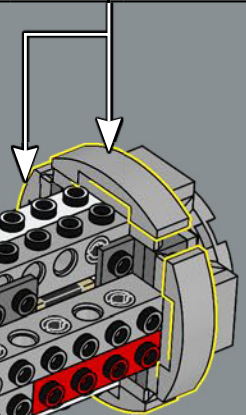
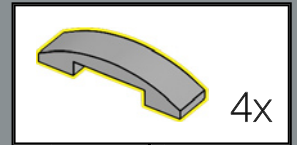
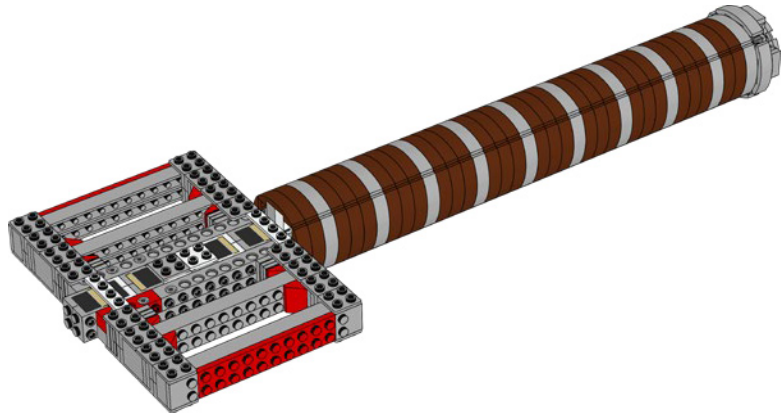
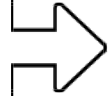

47

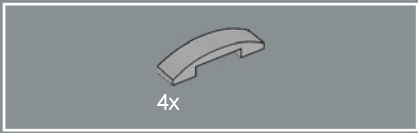

48

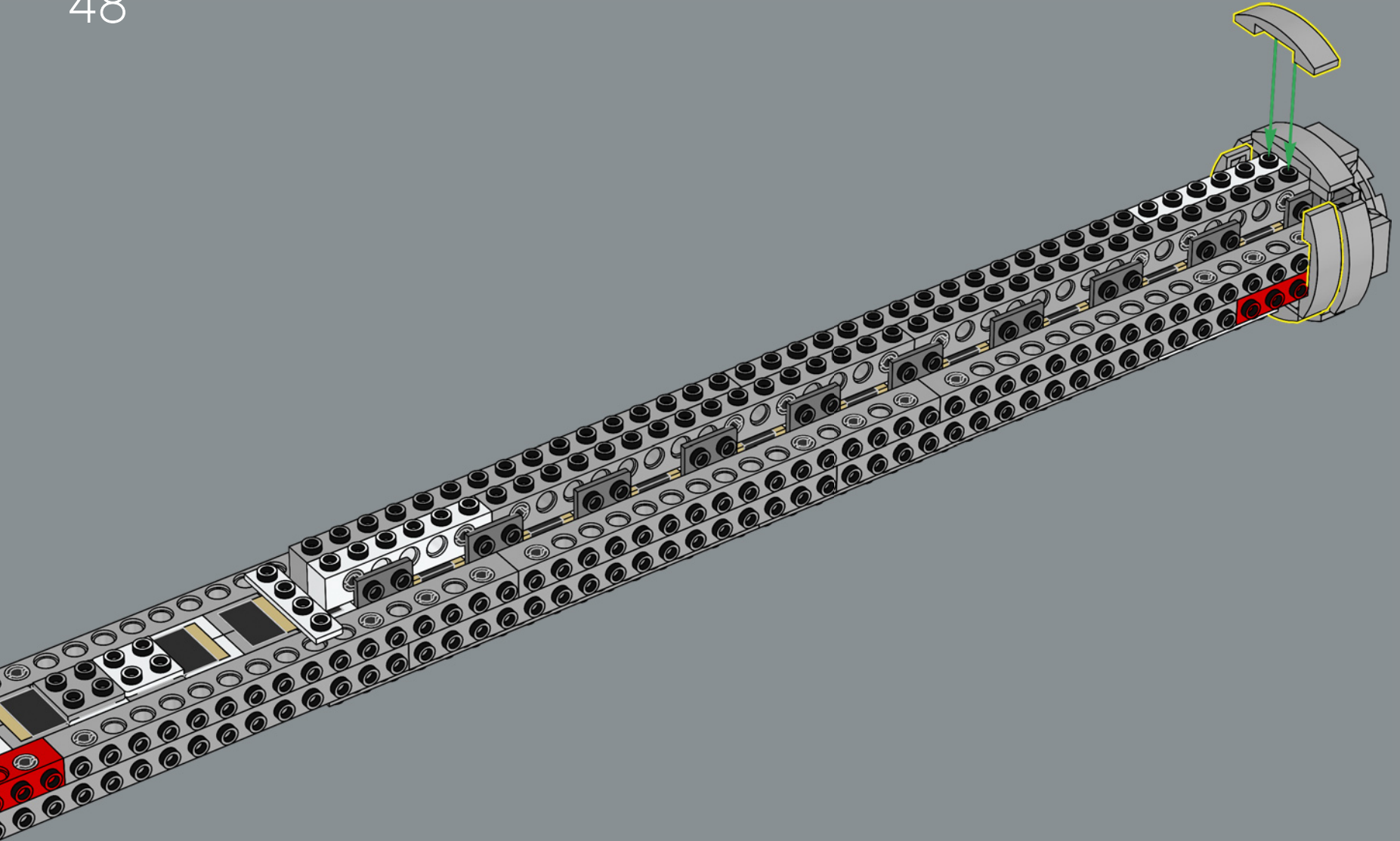

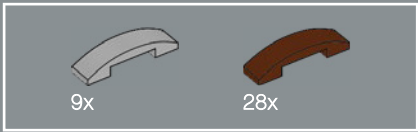

49

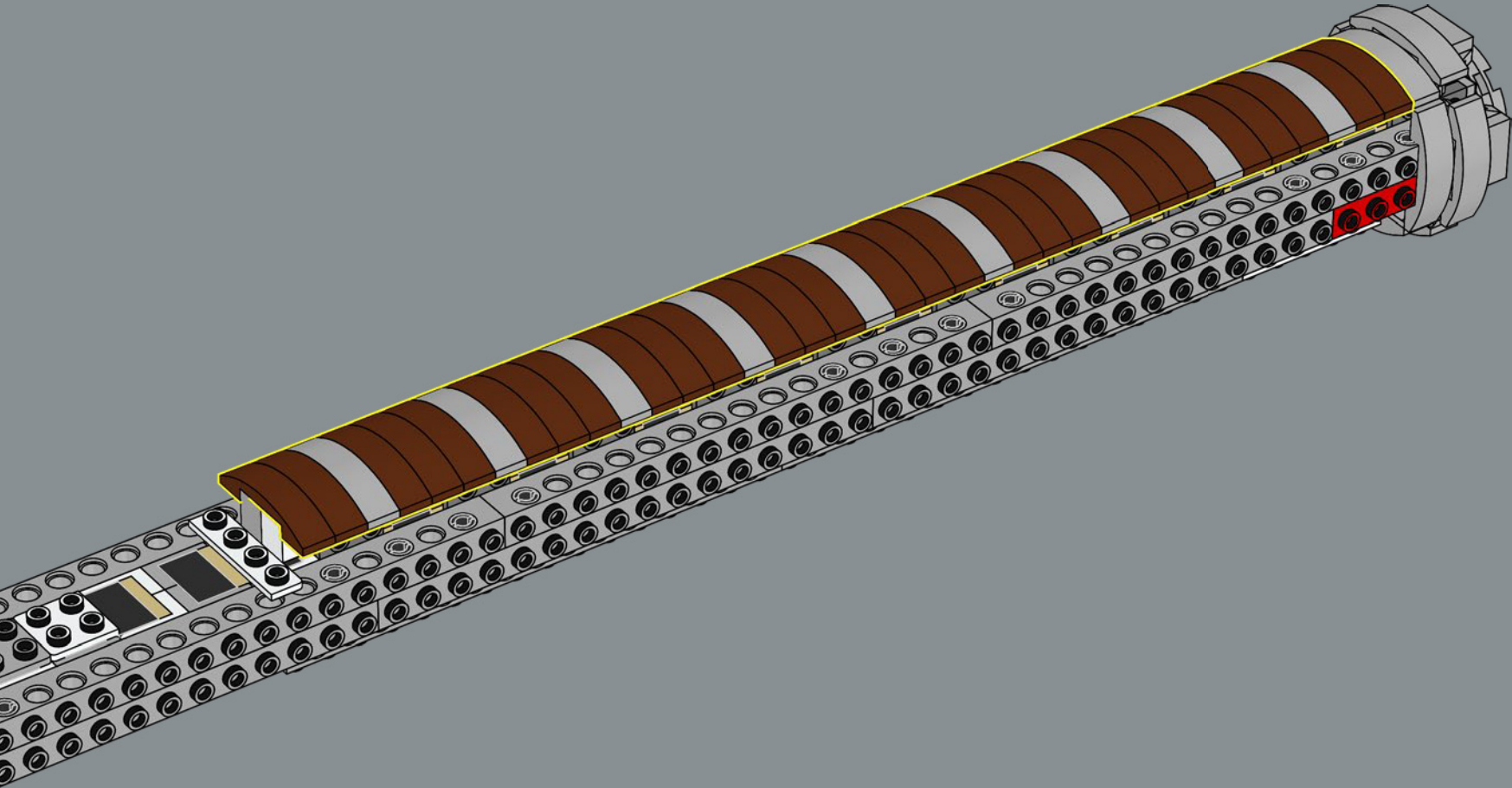



50

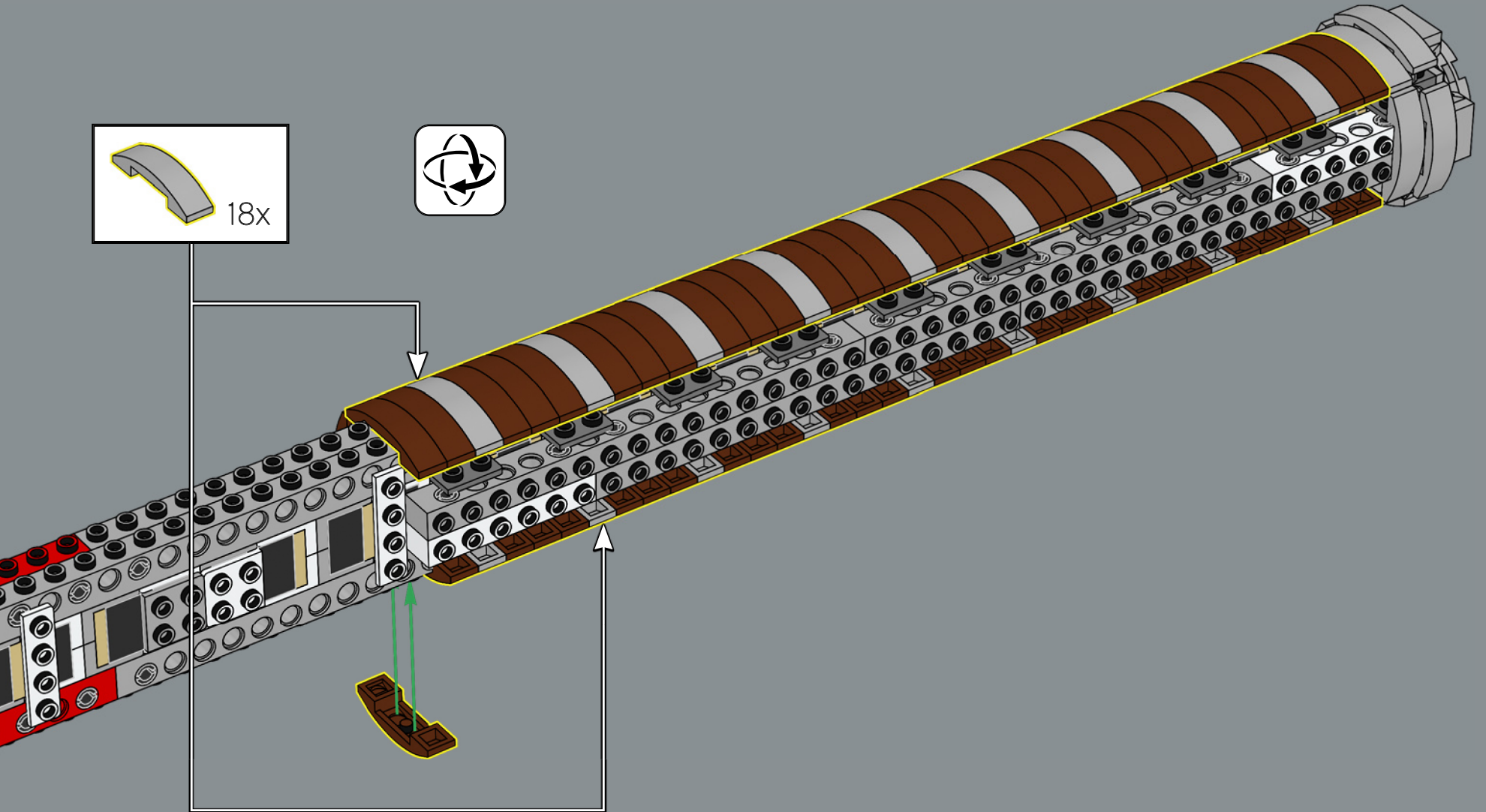
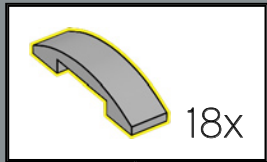

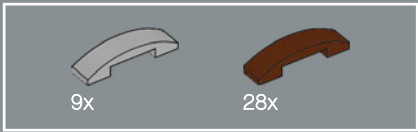

51

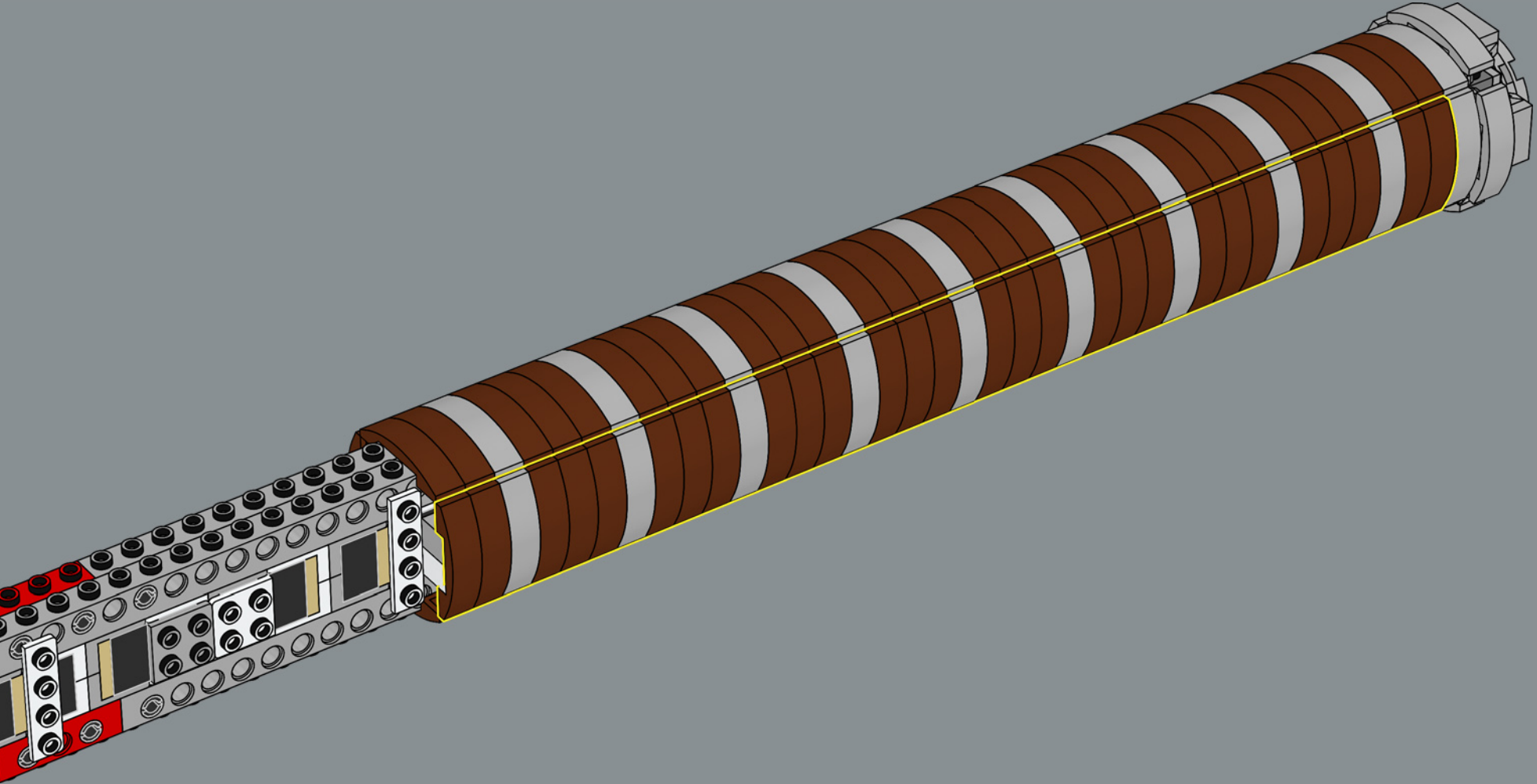

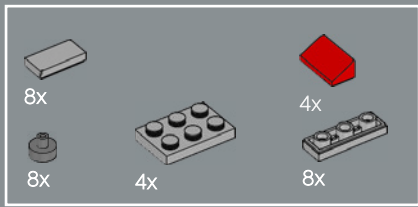

52

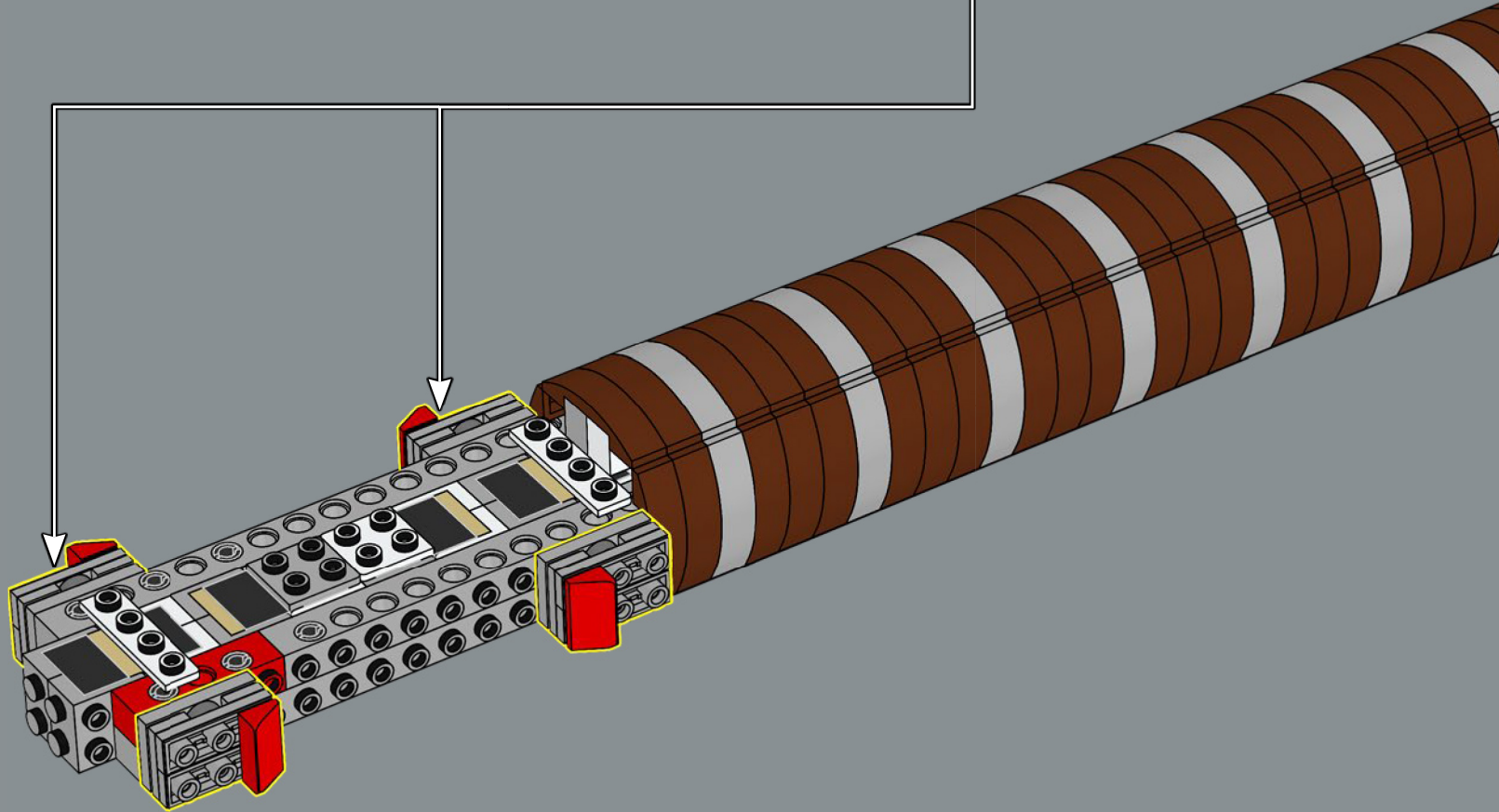
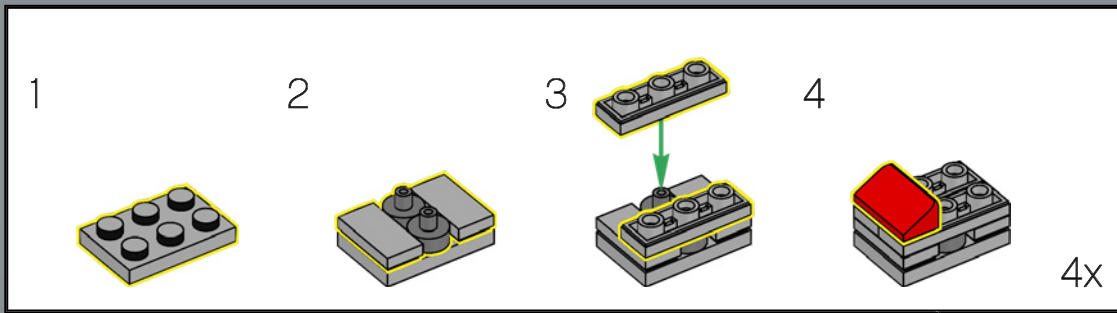



8x

53



8x

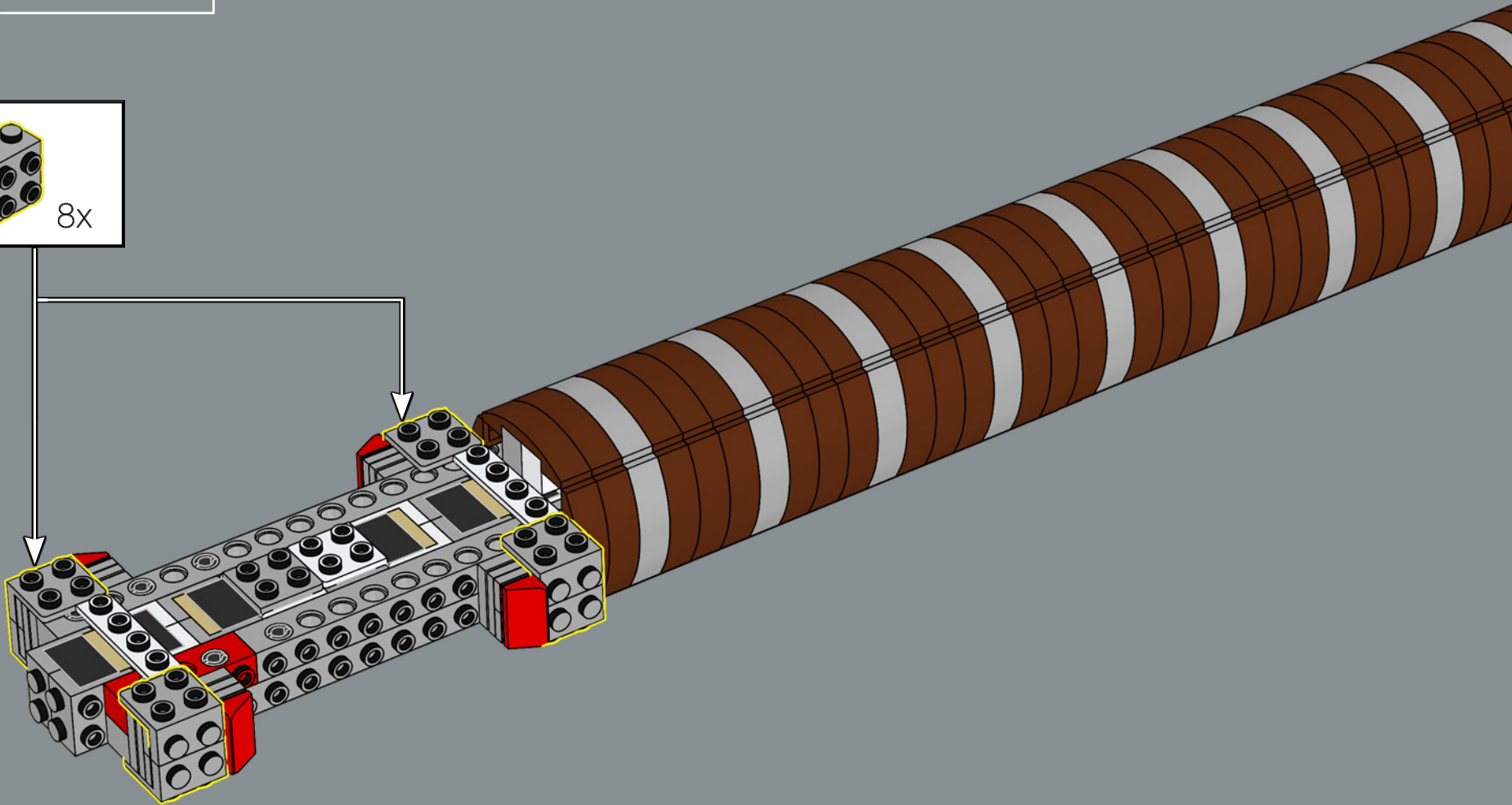

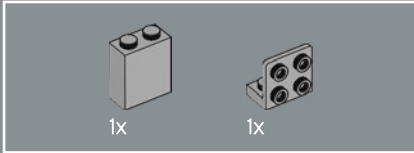
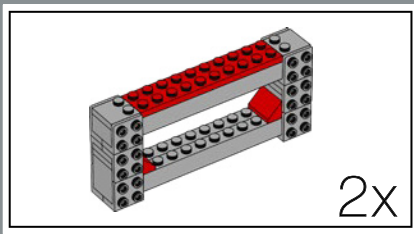

54

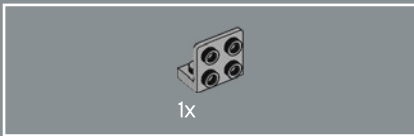
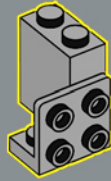

55

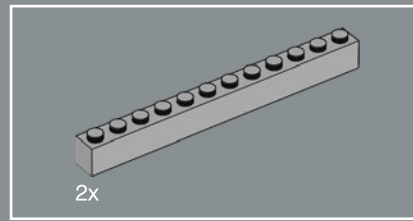
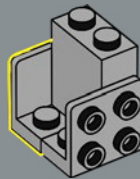

56

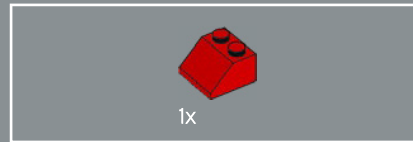
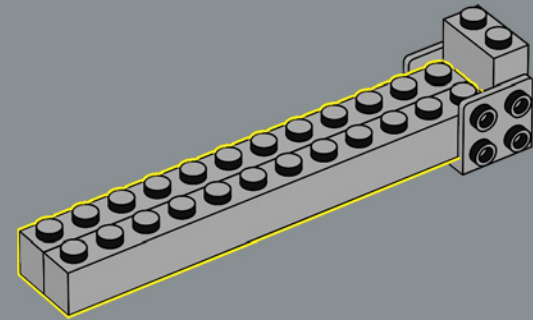

57

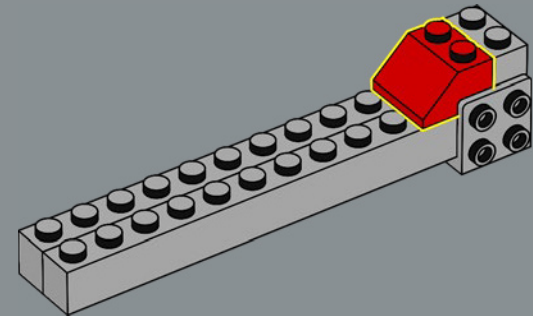



2x

58

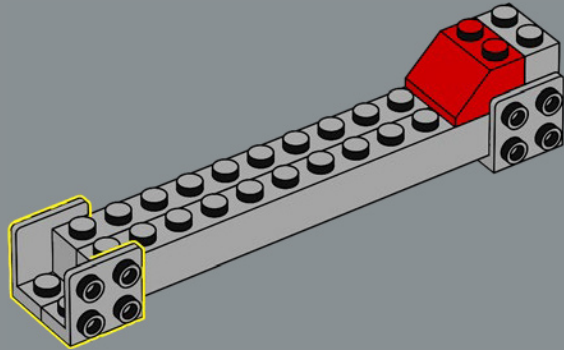

1x

59

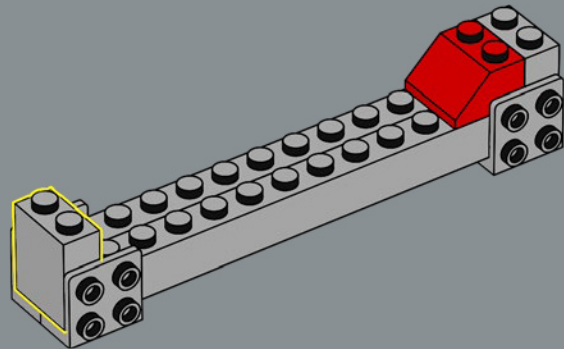

1x

60

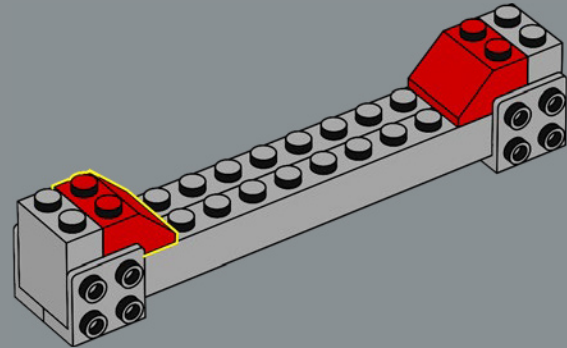

4x

61

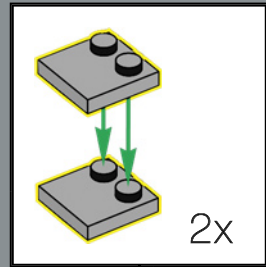

2x

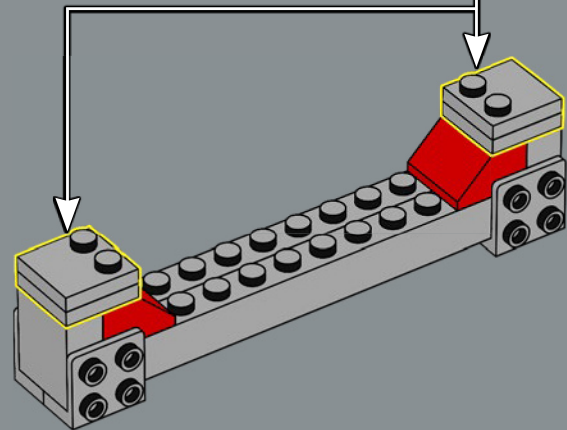



62

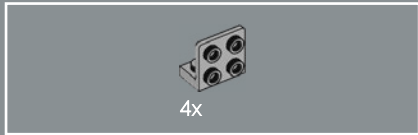
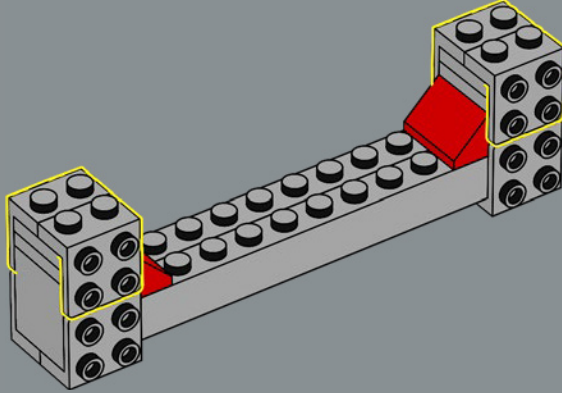

63

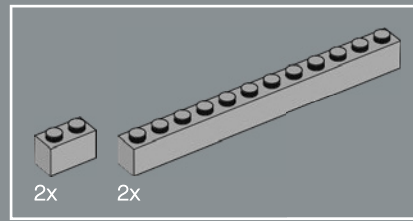
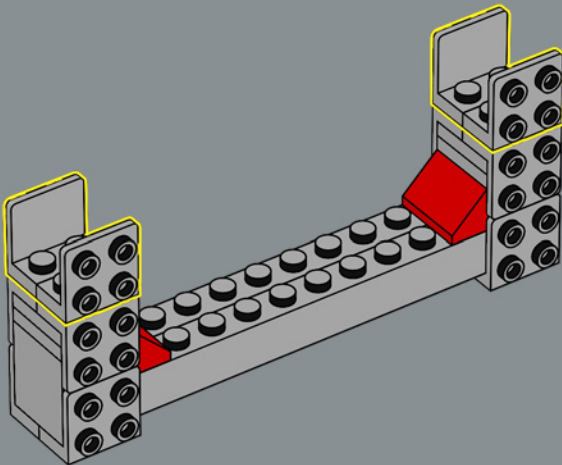

64

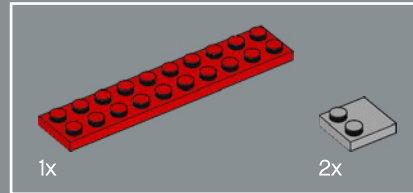
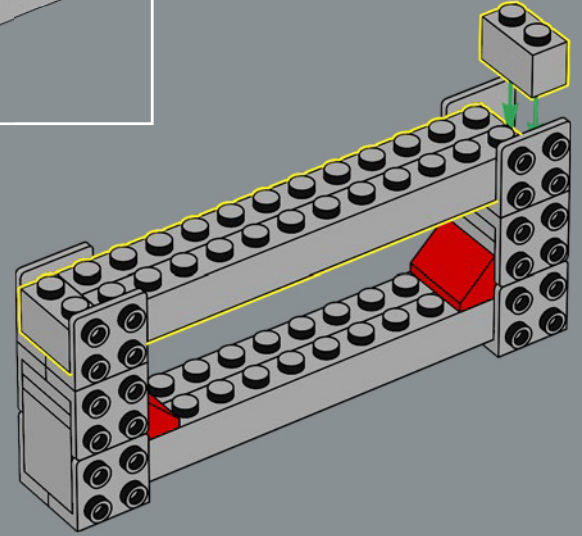

65

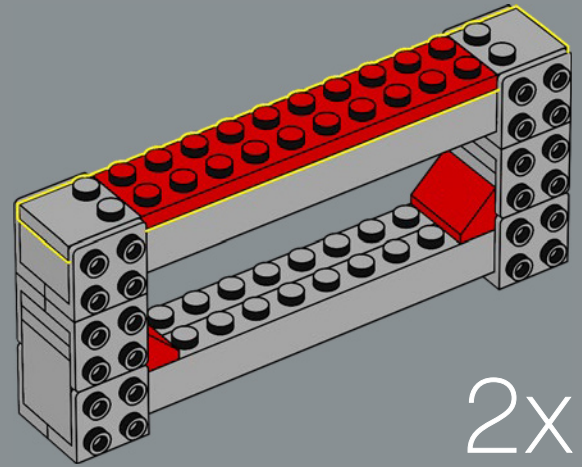

2x

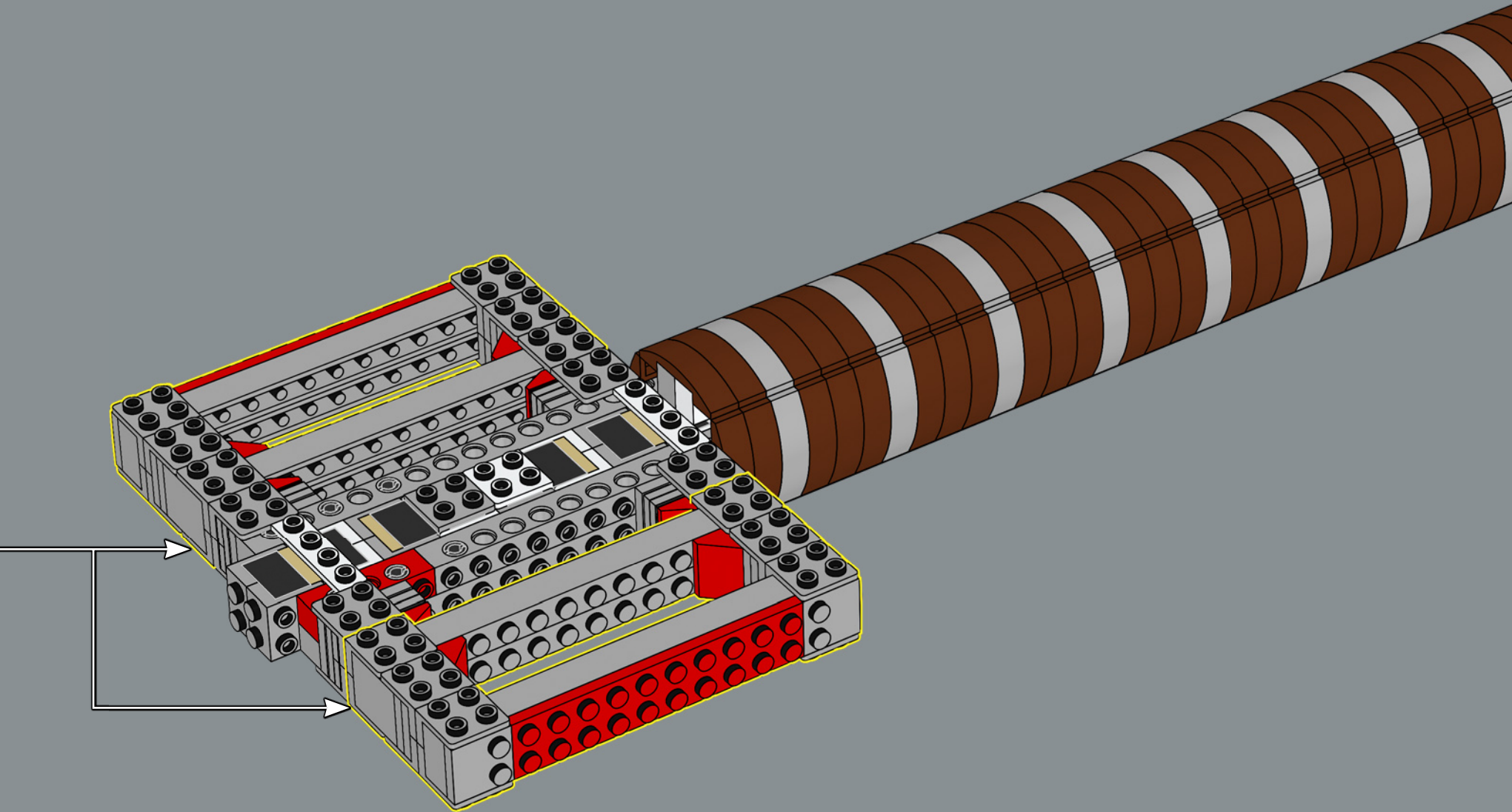

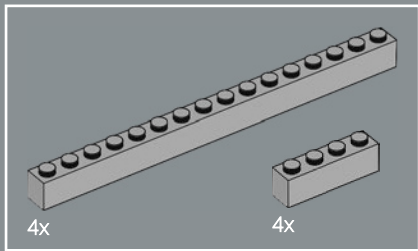
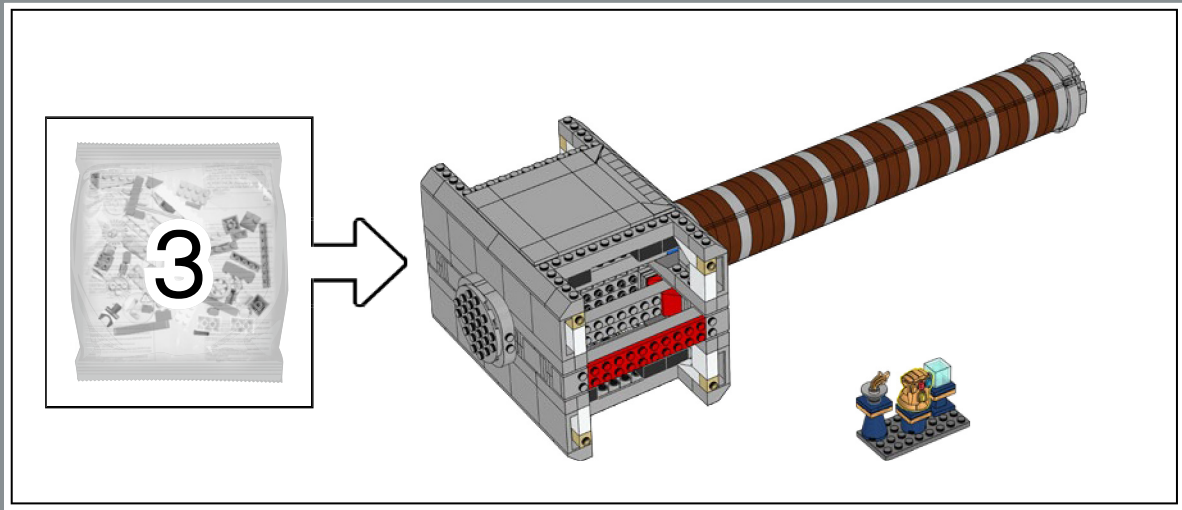

67

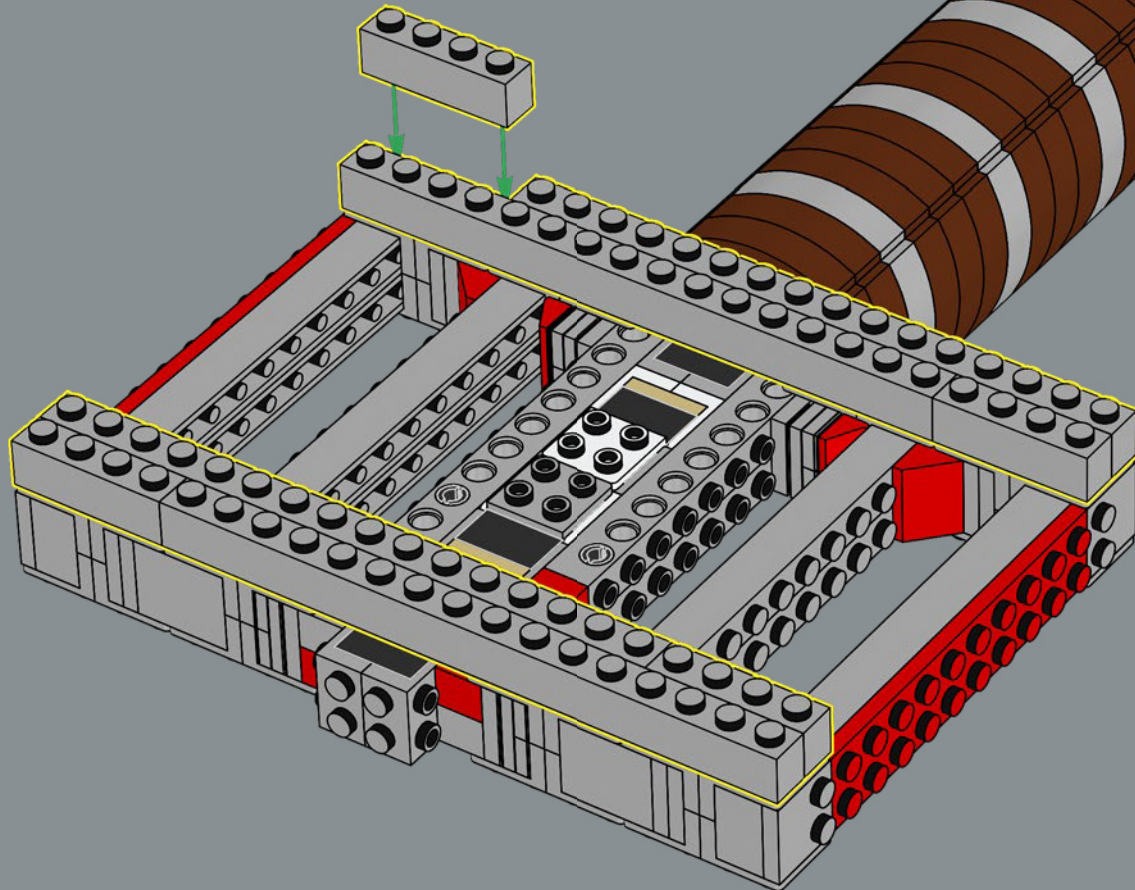

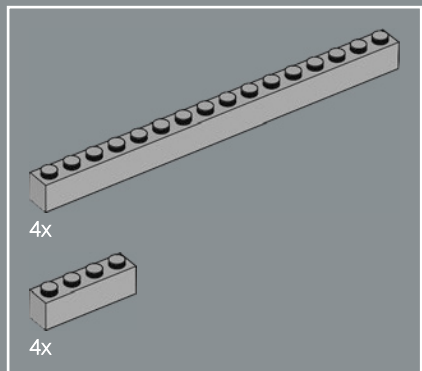

68

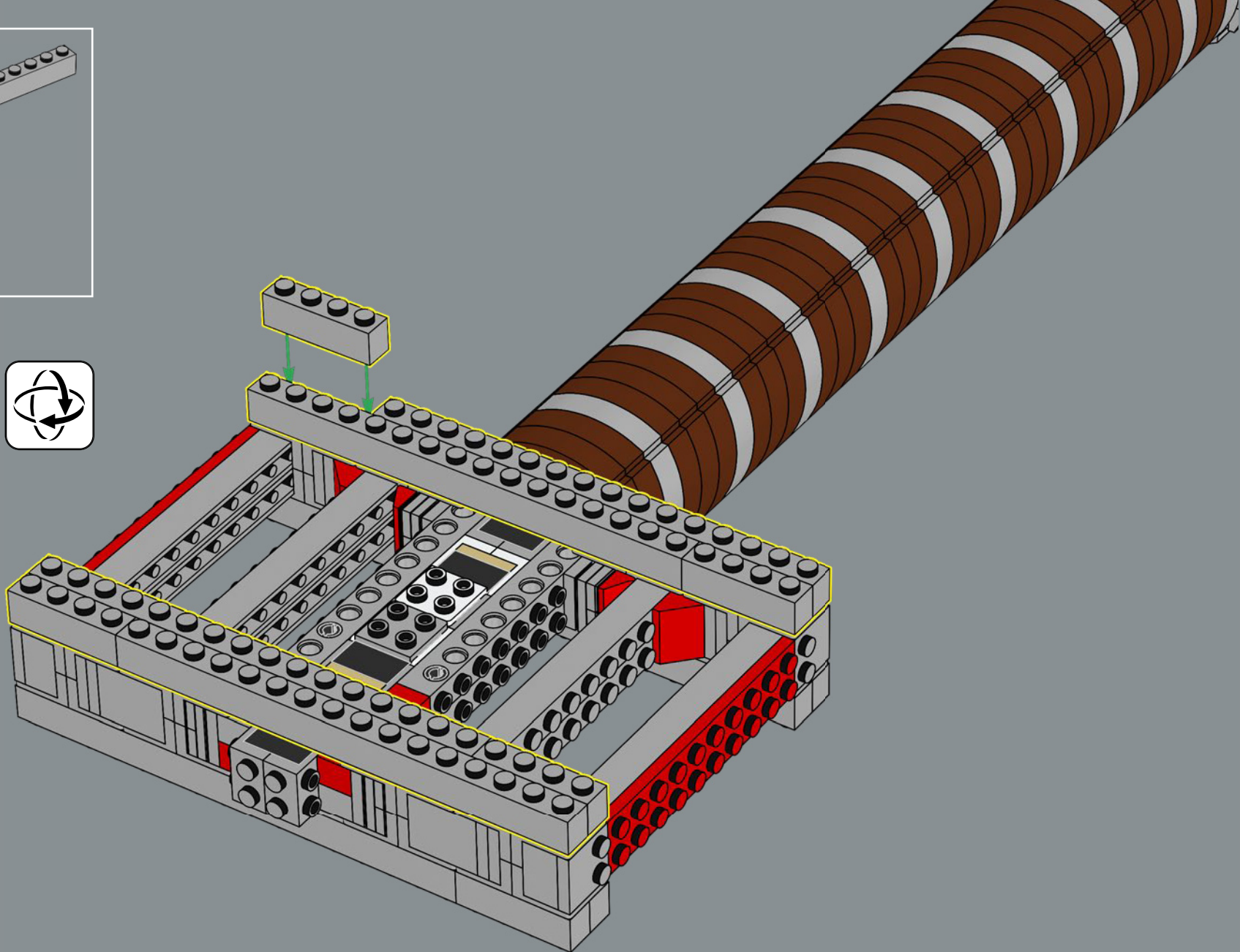

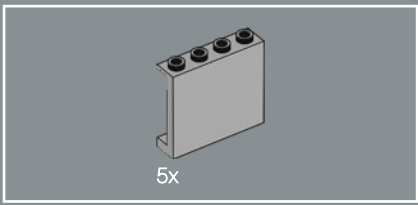

69

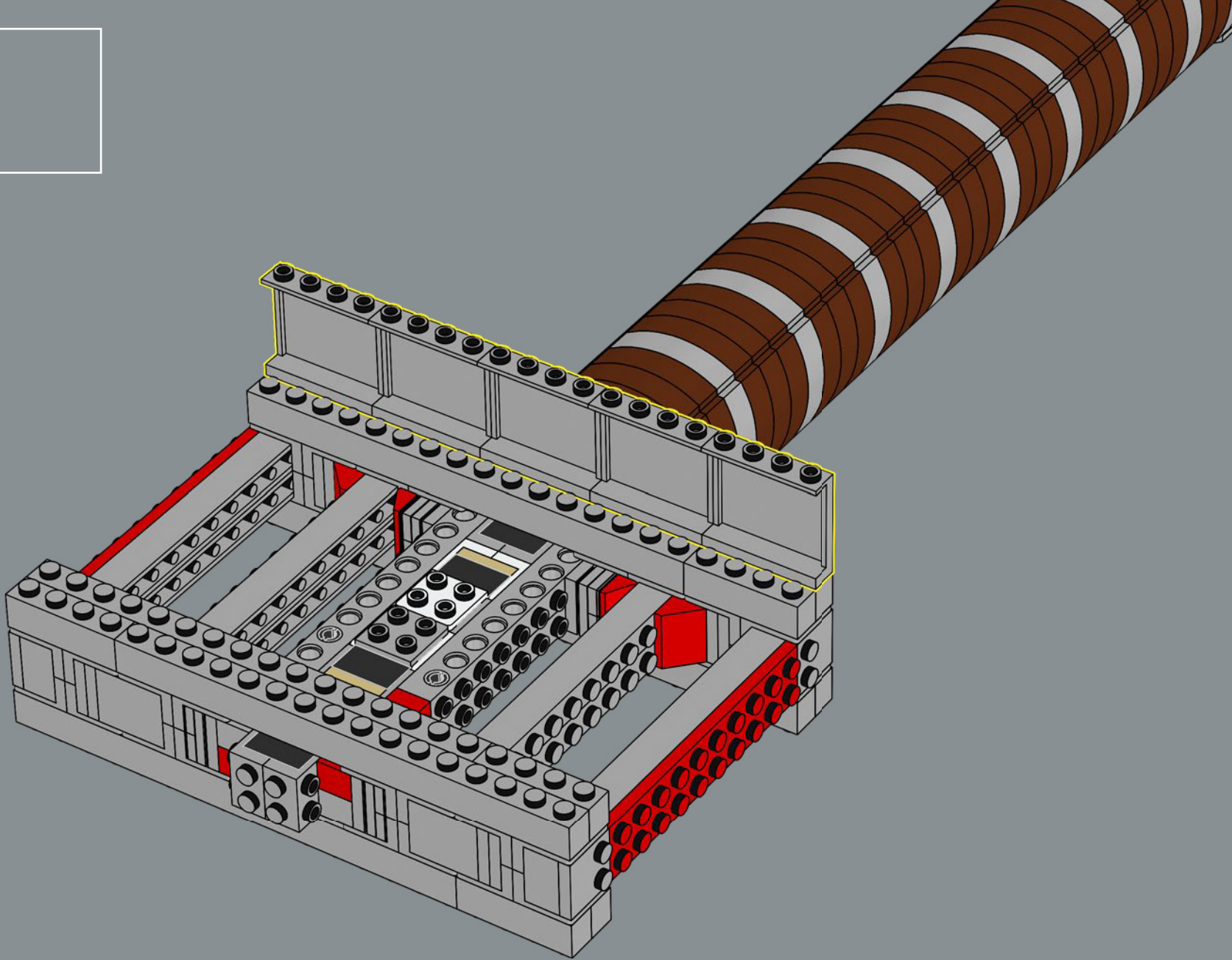

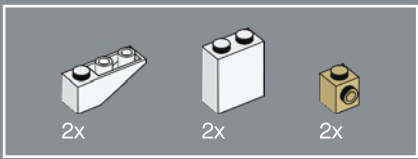

70

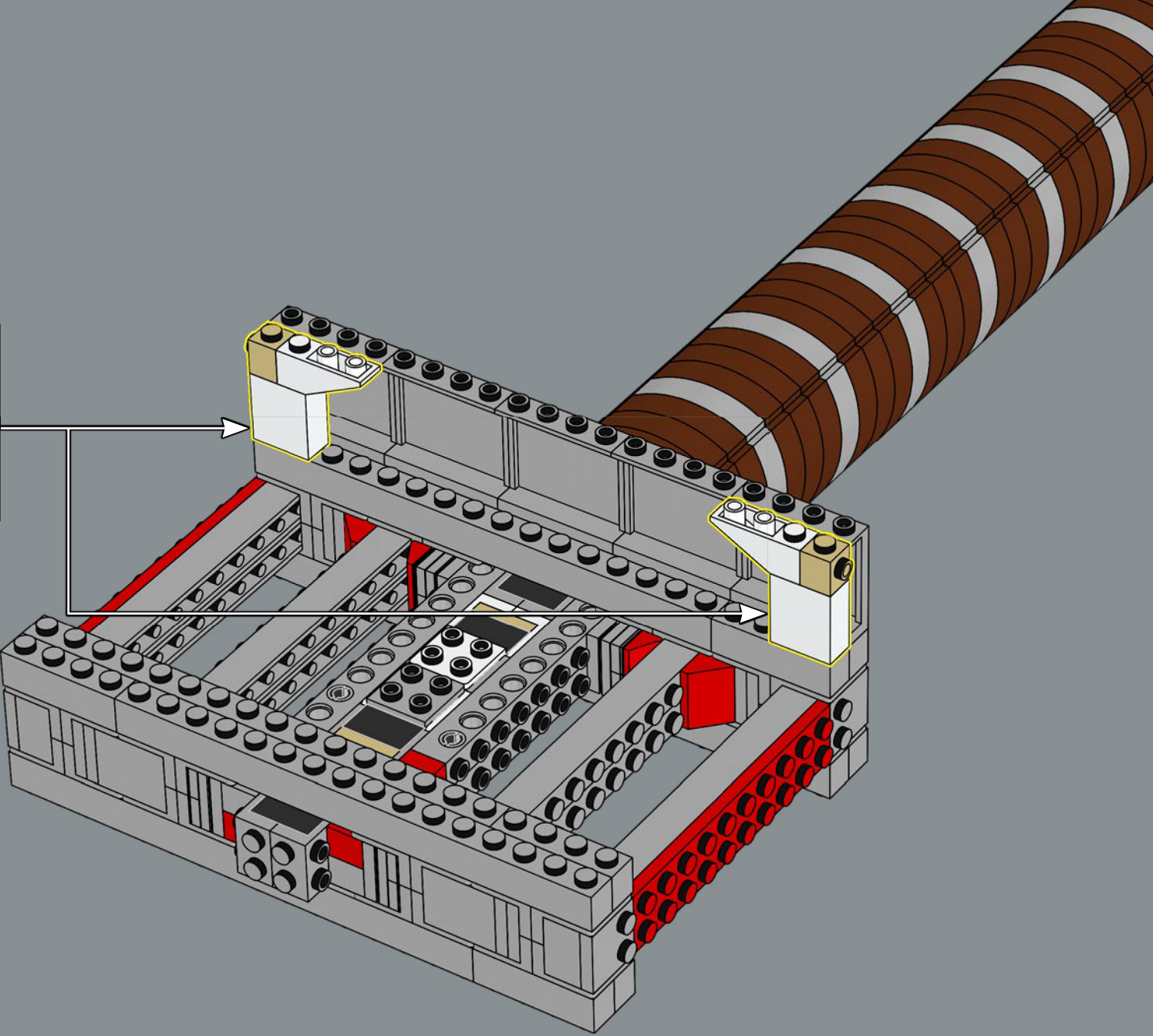
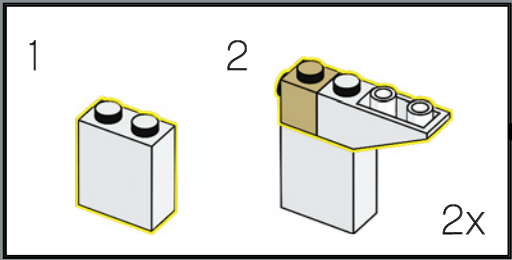

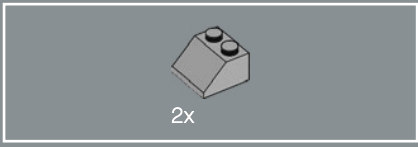

71

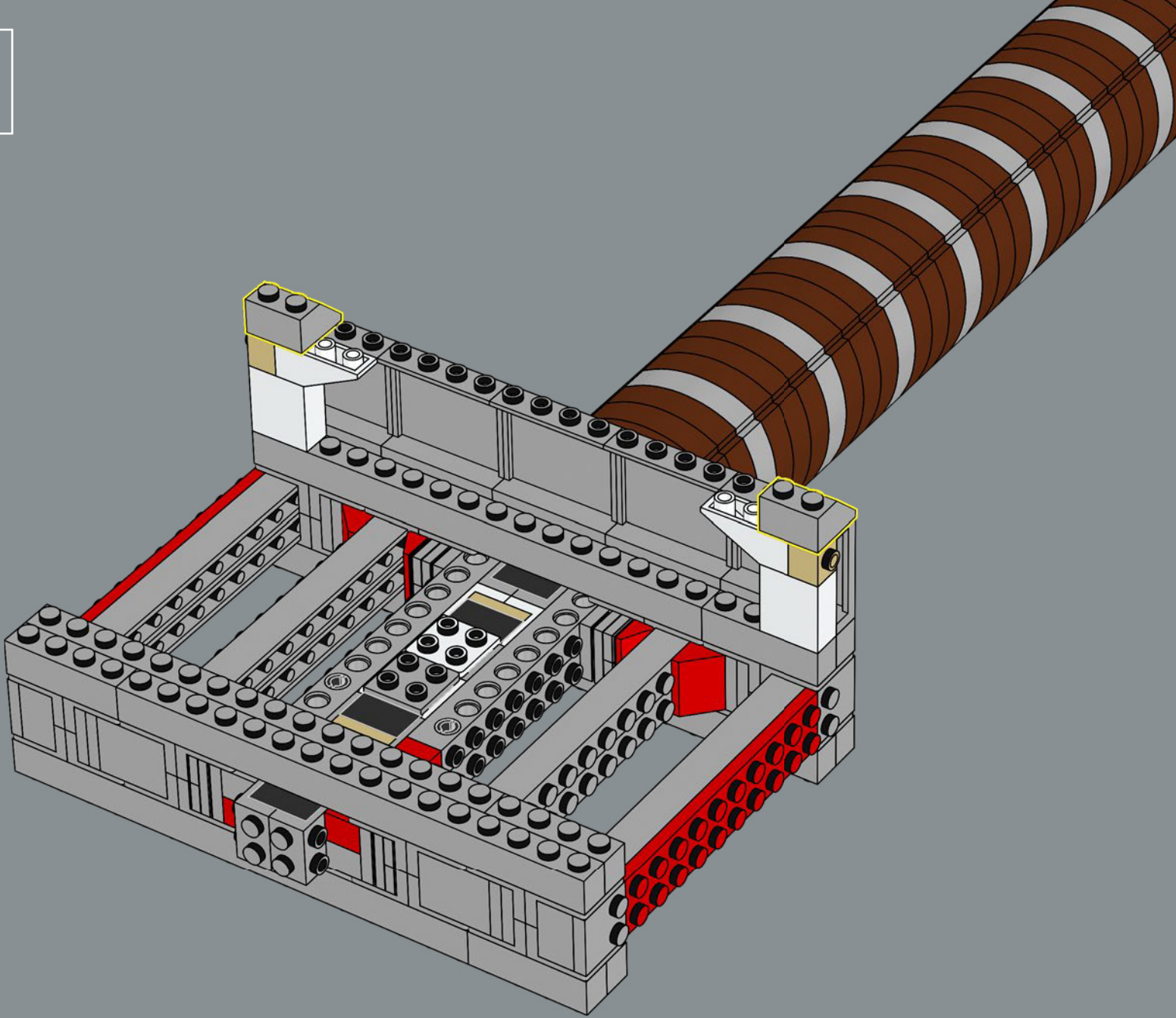

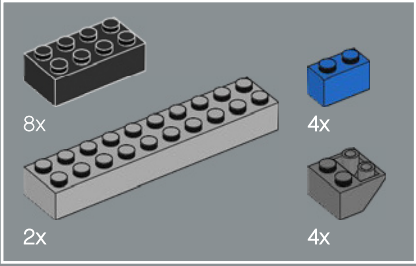
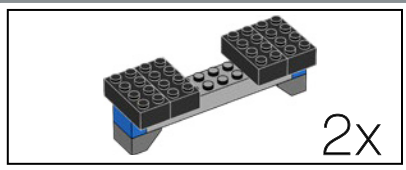

72

1

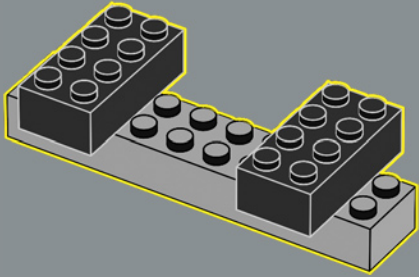

2

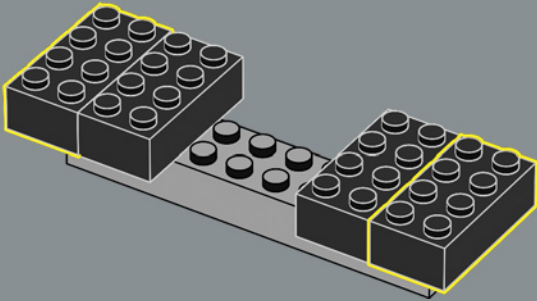

3

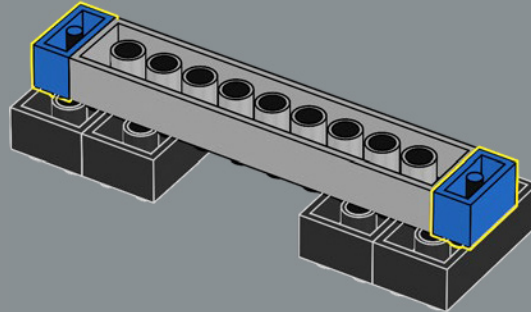

4

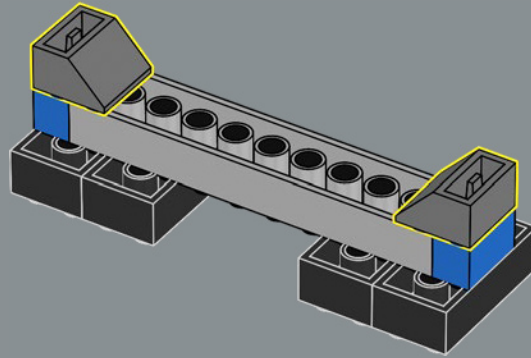

2x

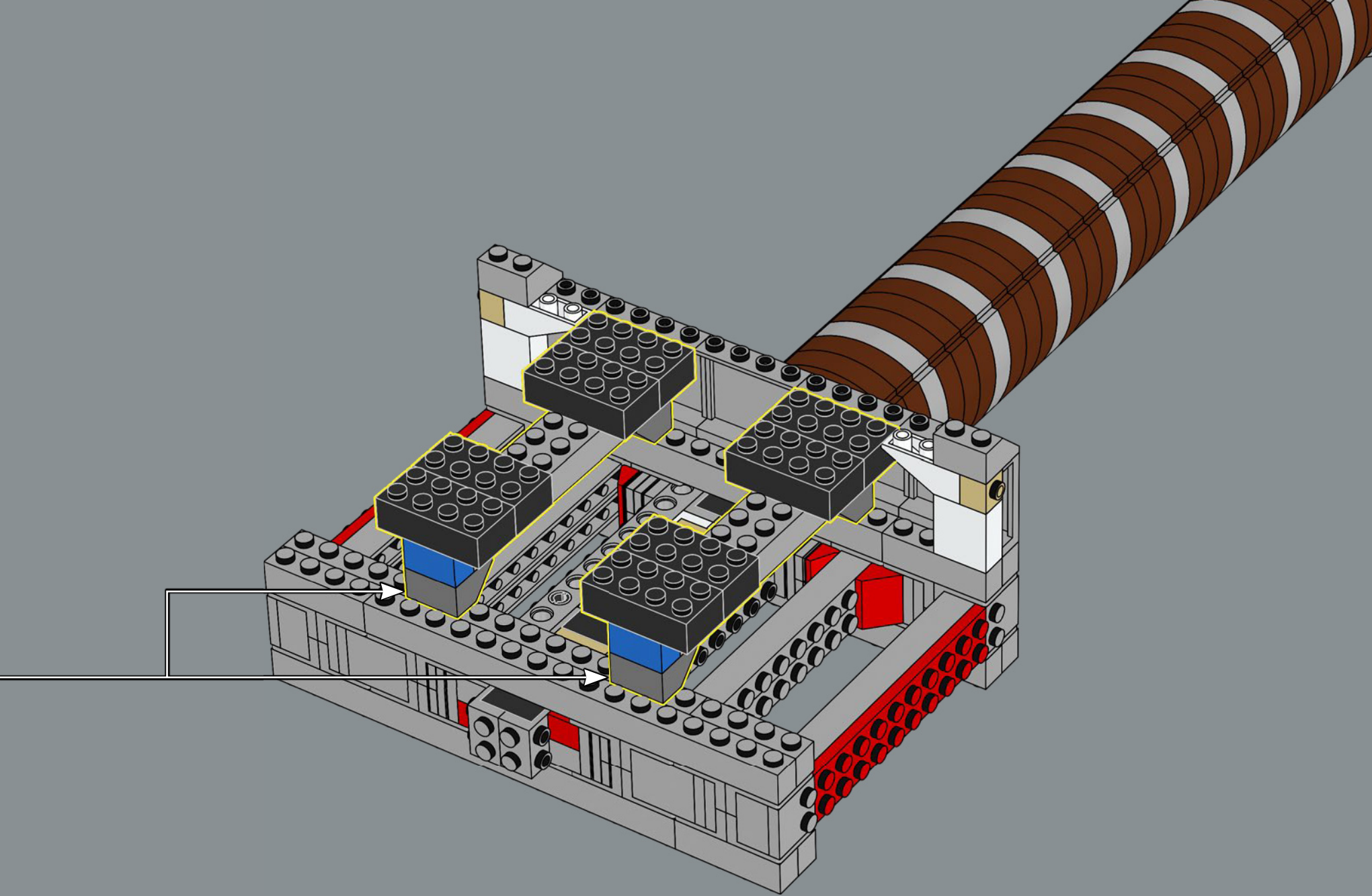

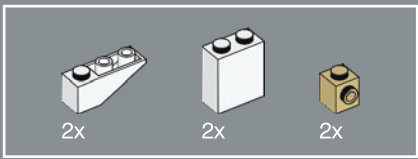

73

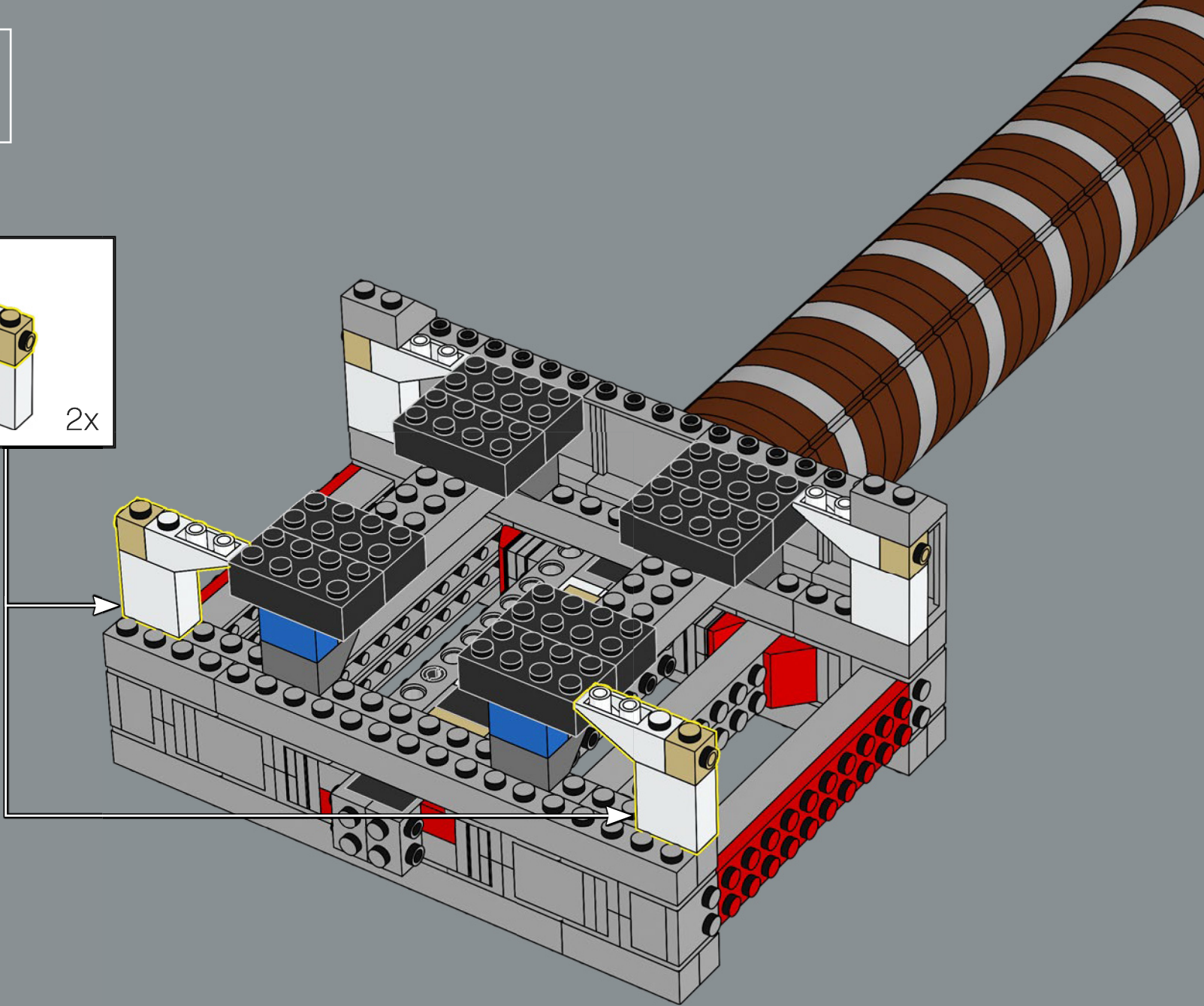
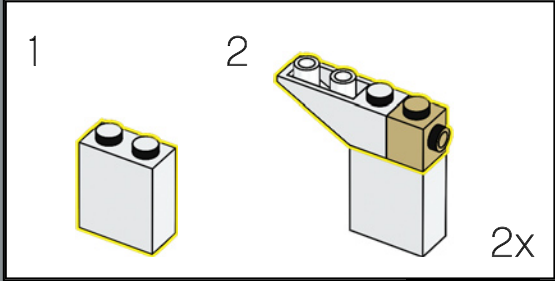

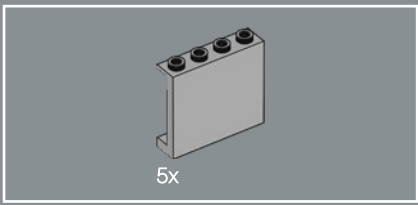

74

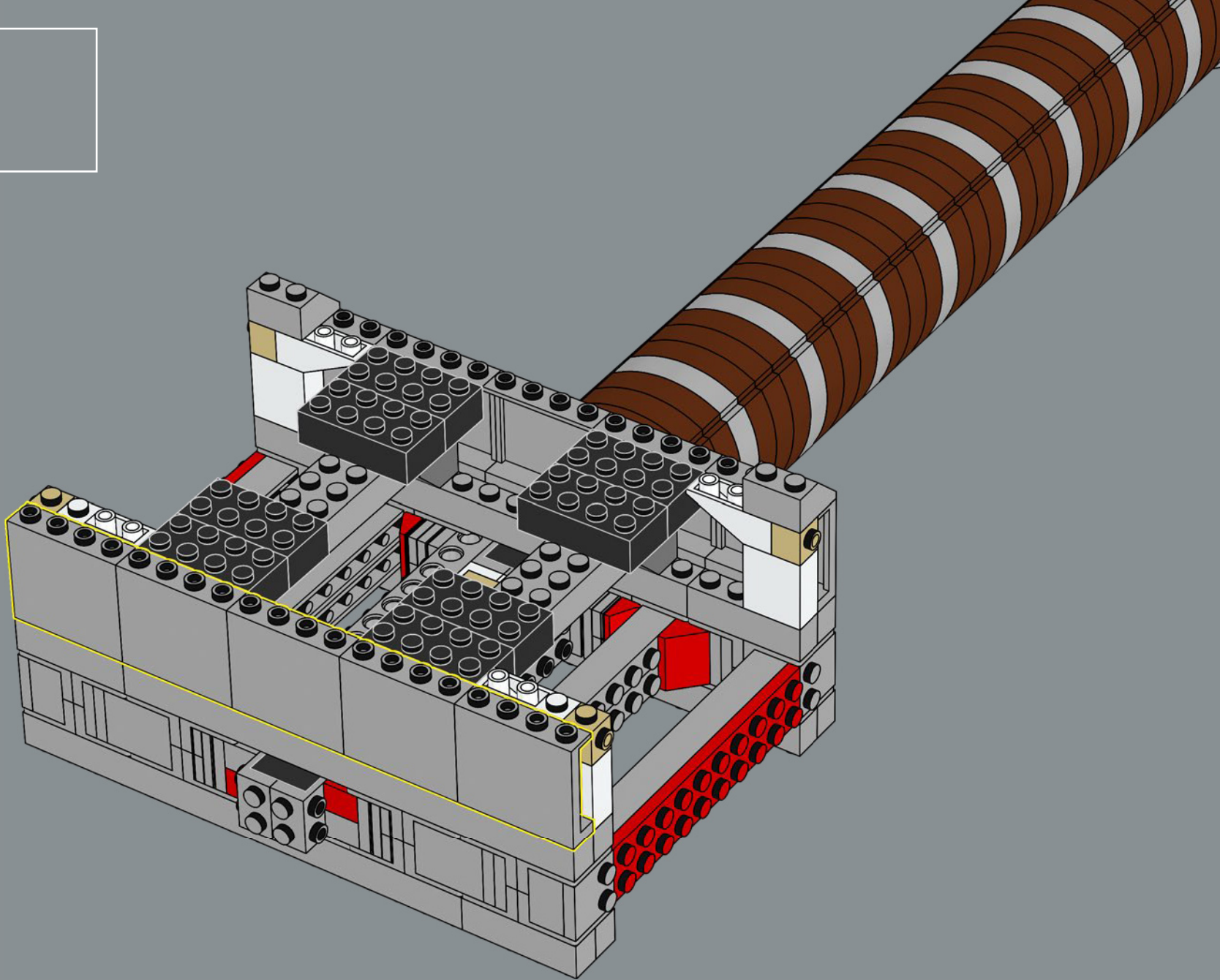

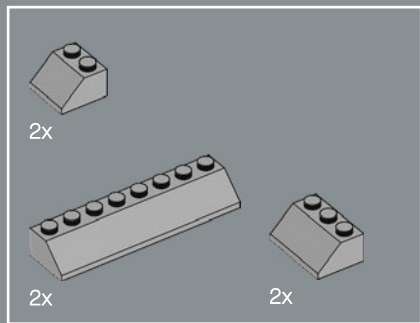

75

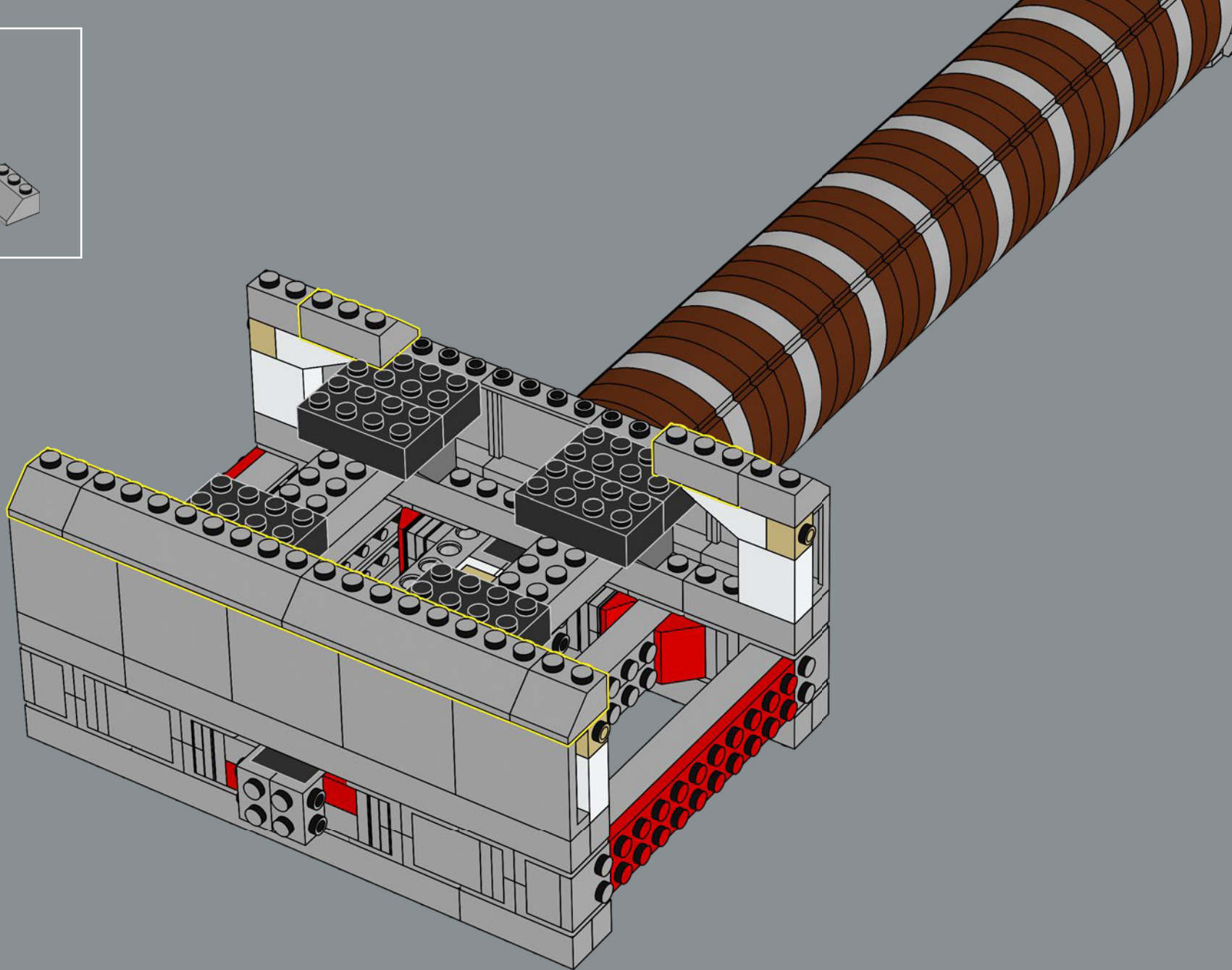

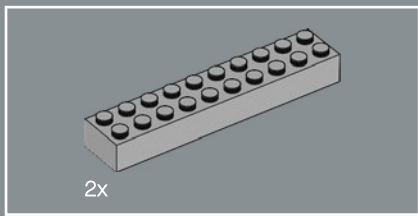

76

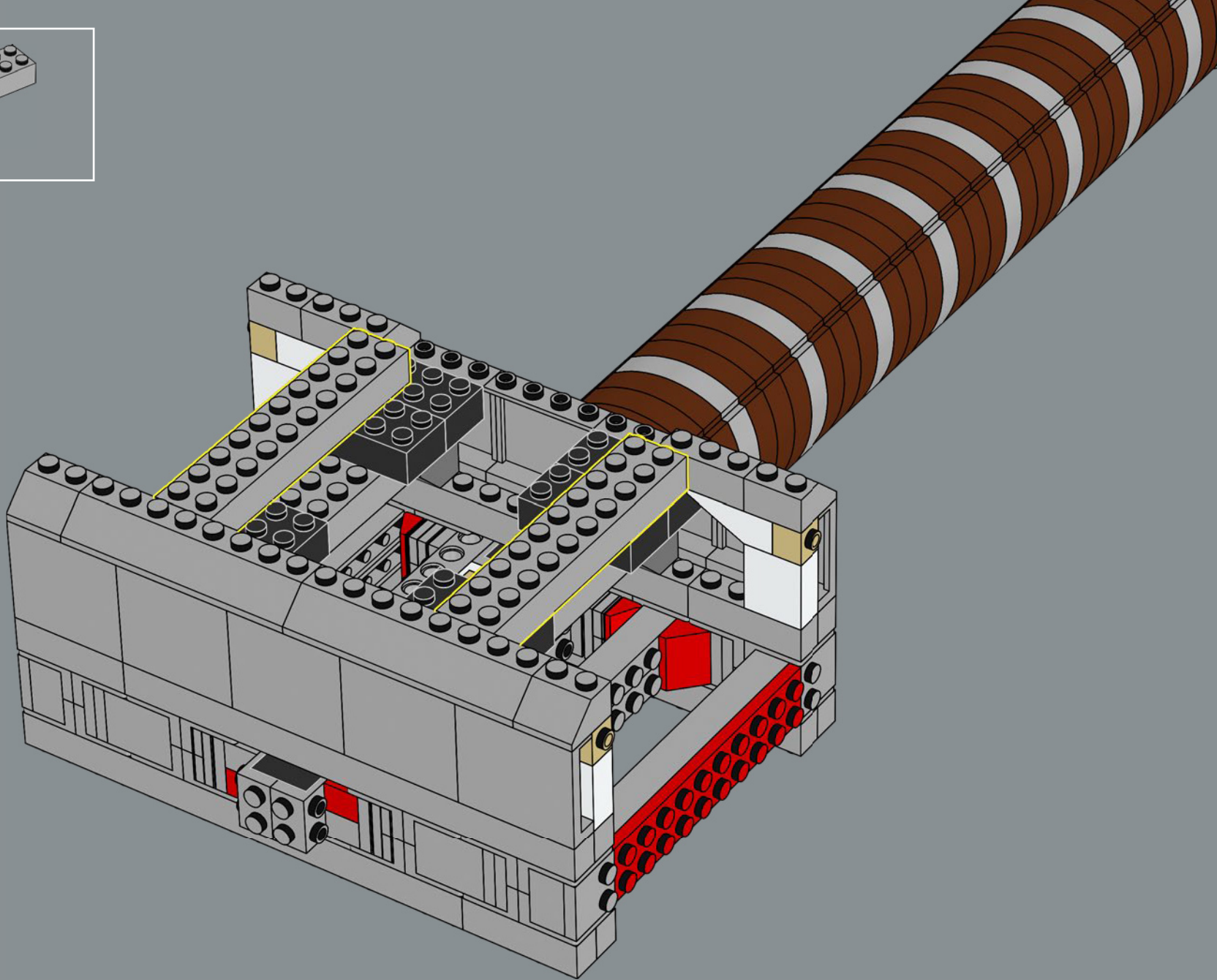

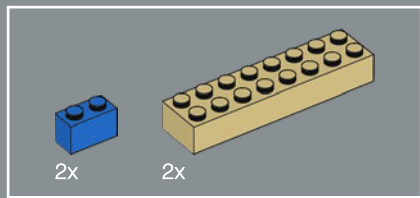

77

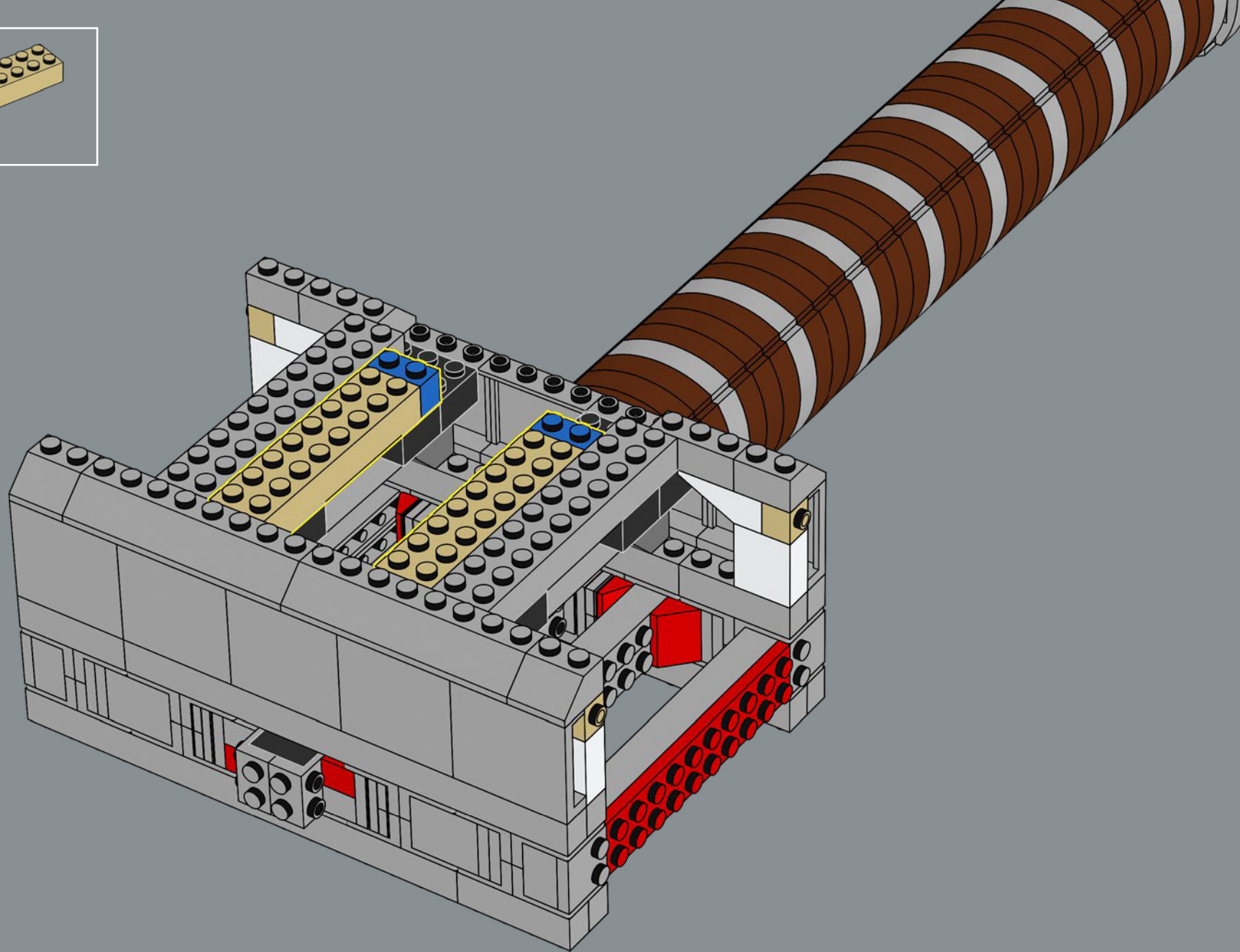

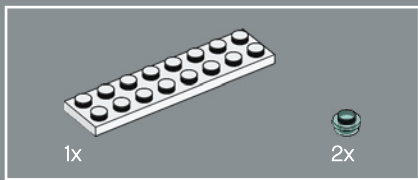

78

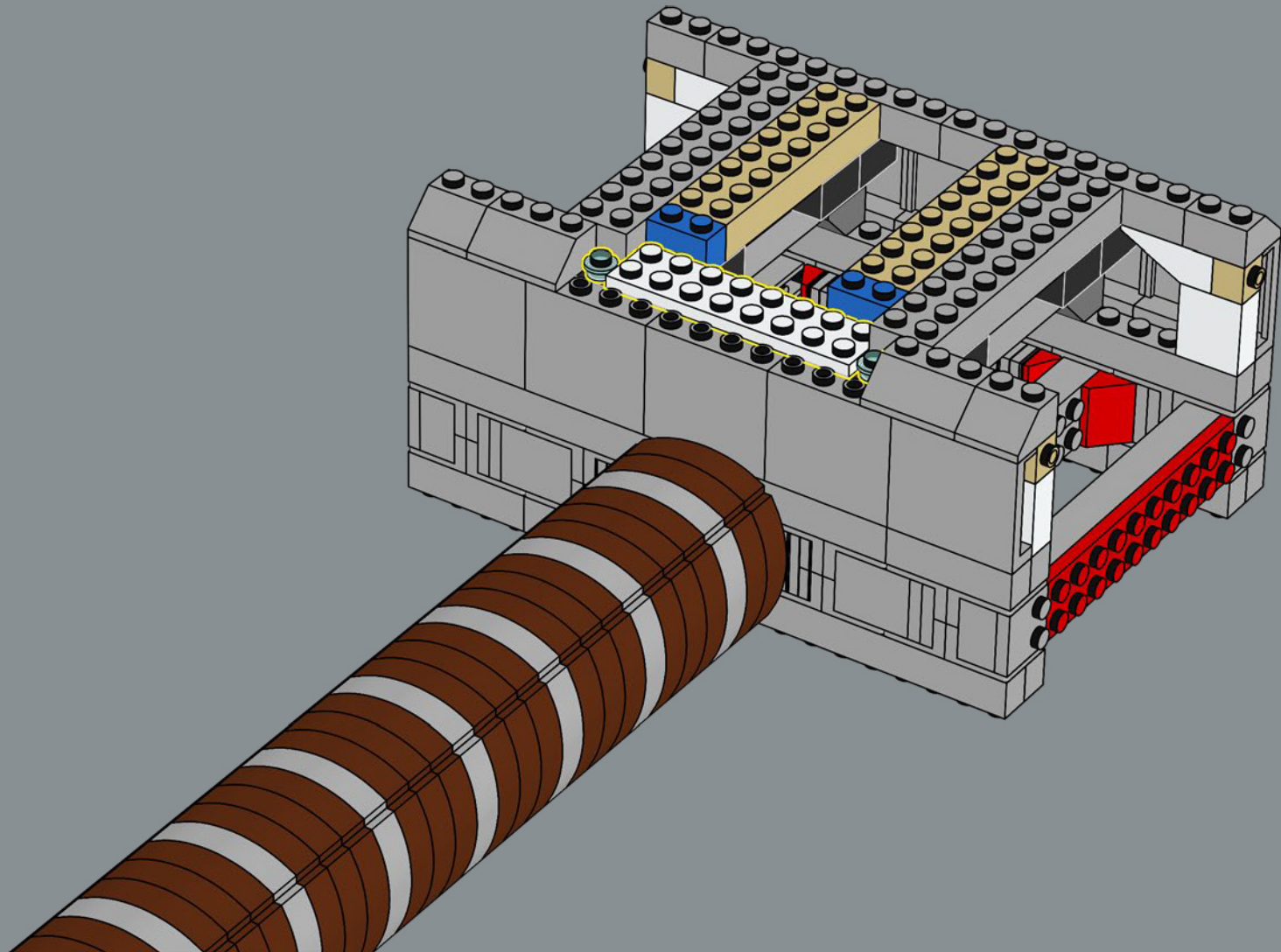

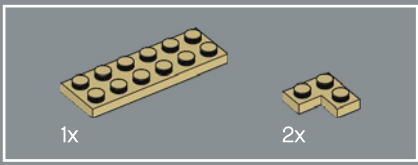

79

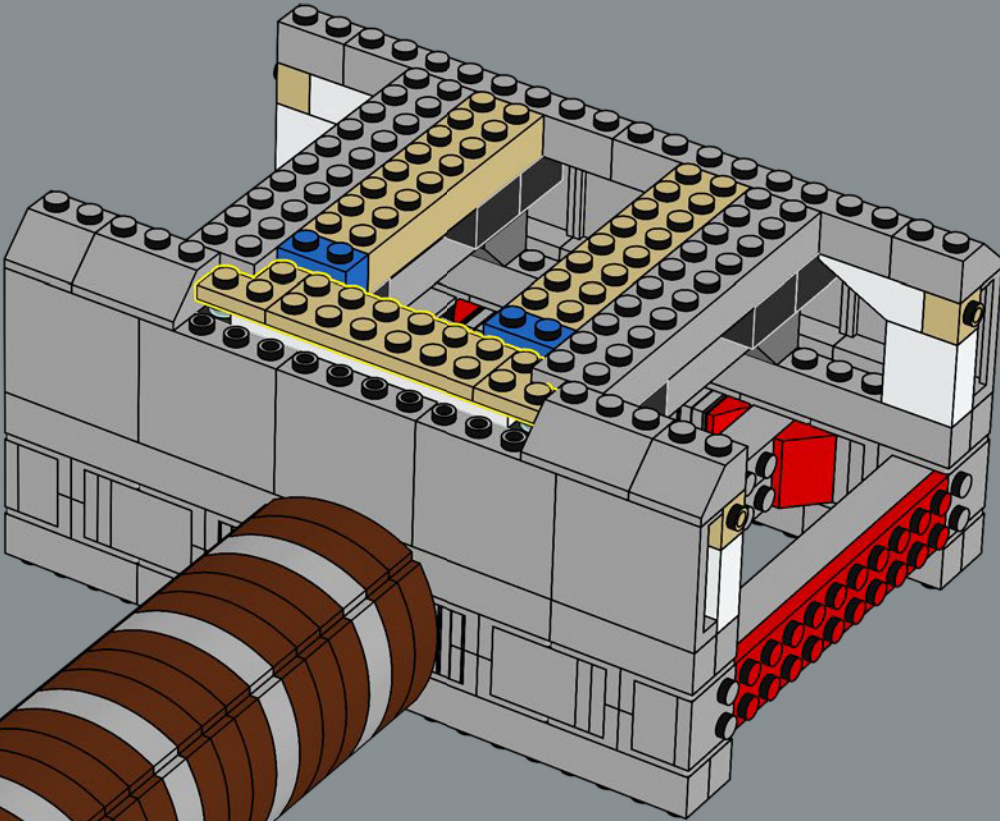

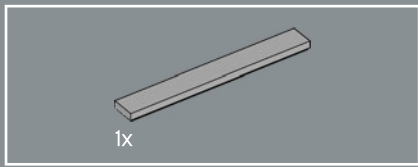

80

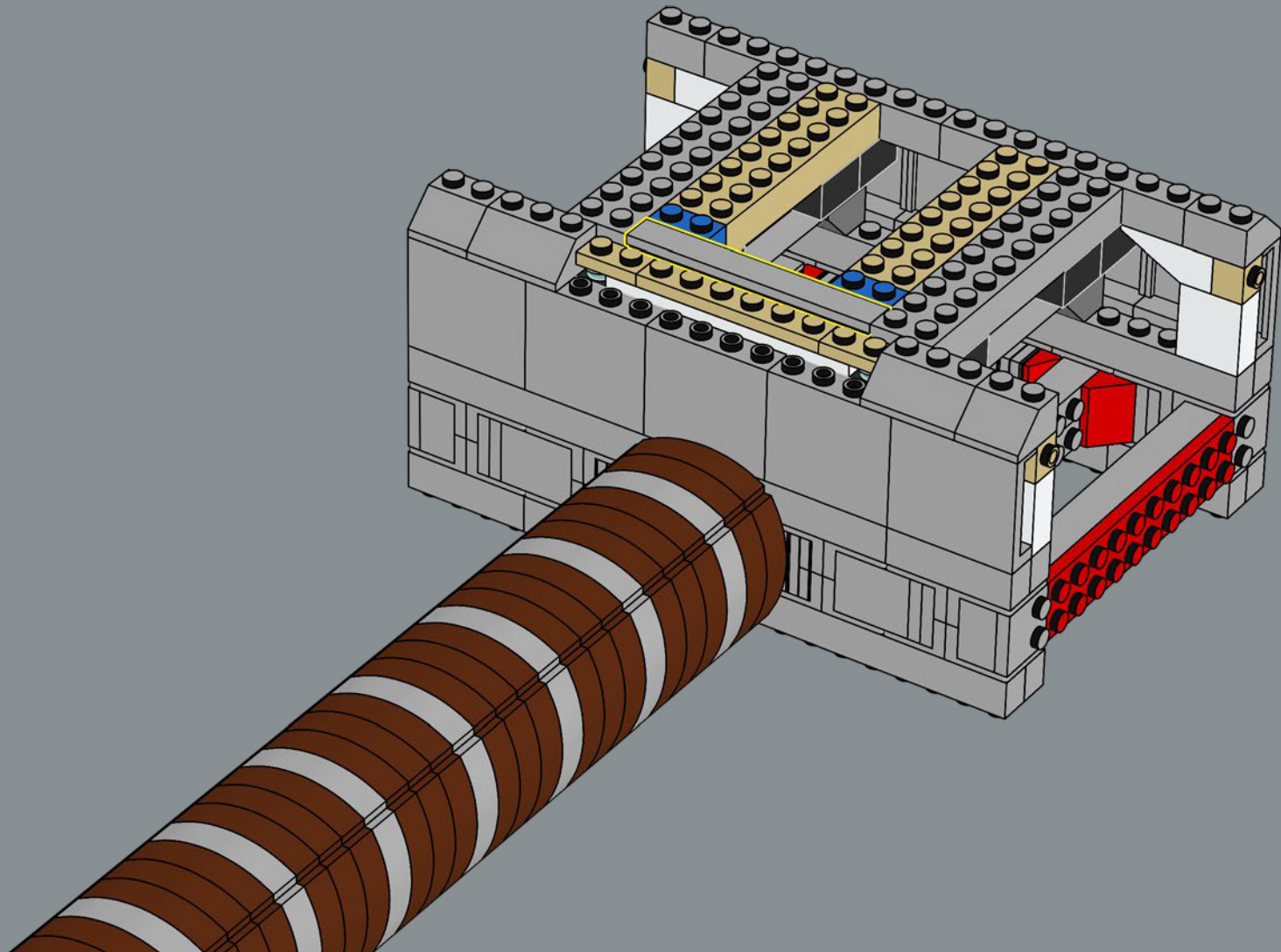



10x

81

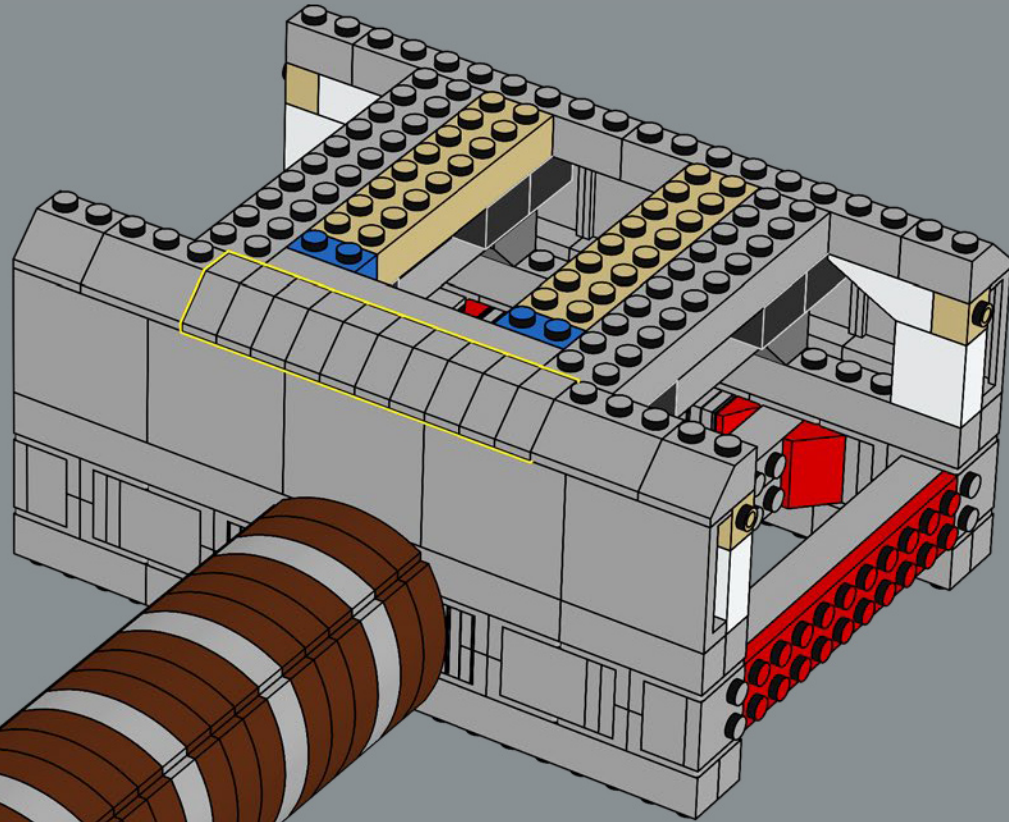

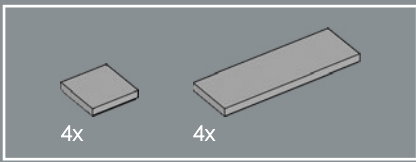

82

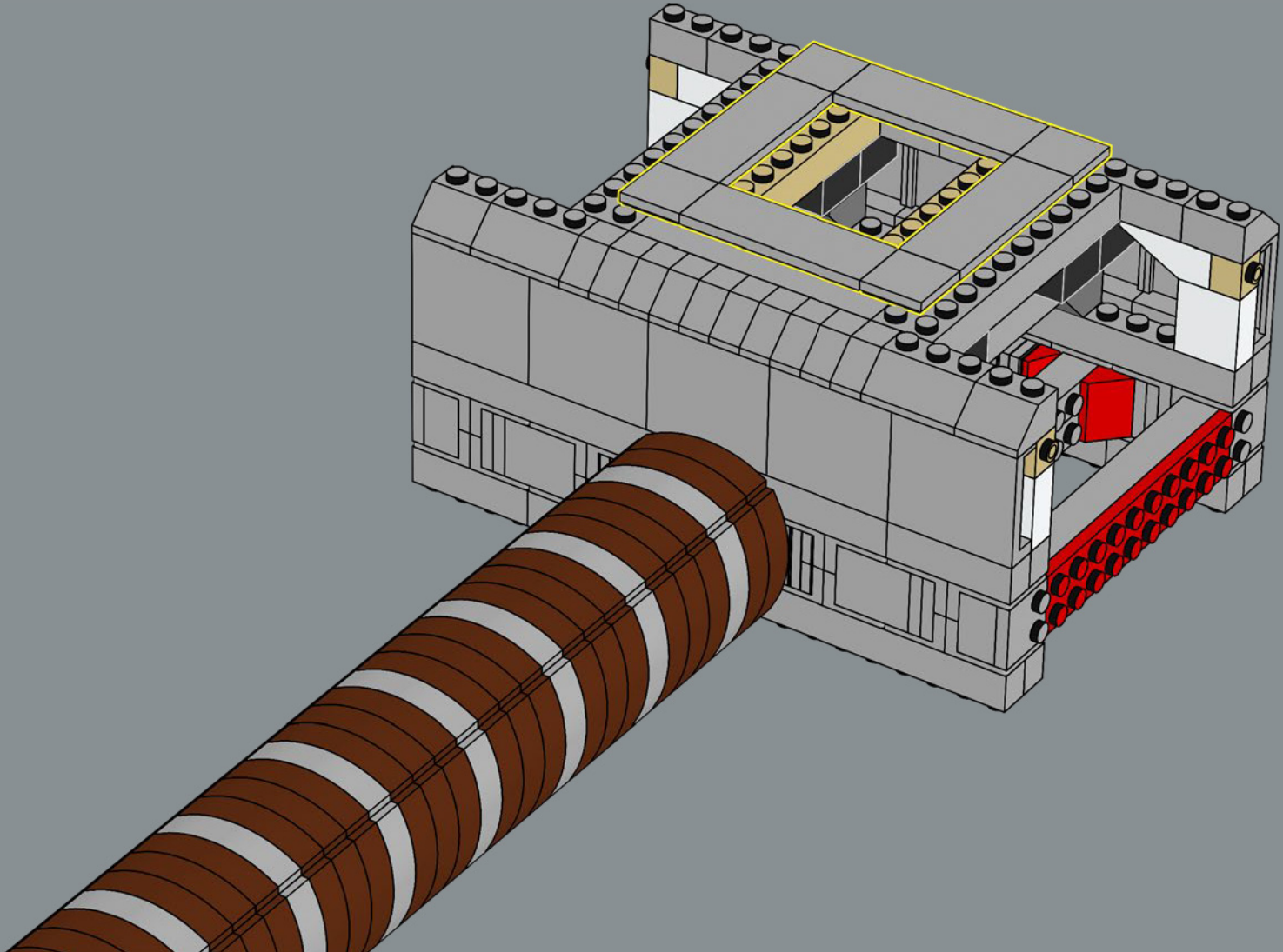

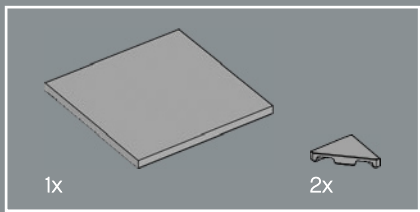

83

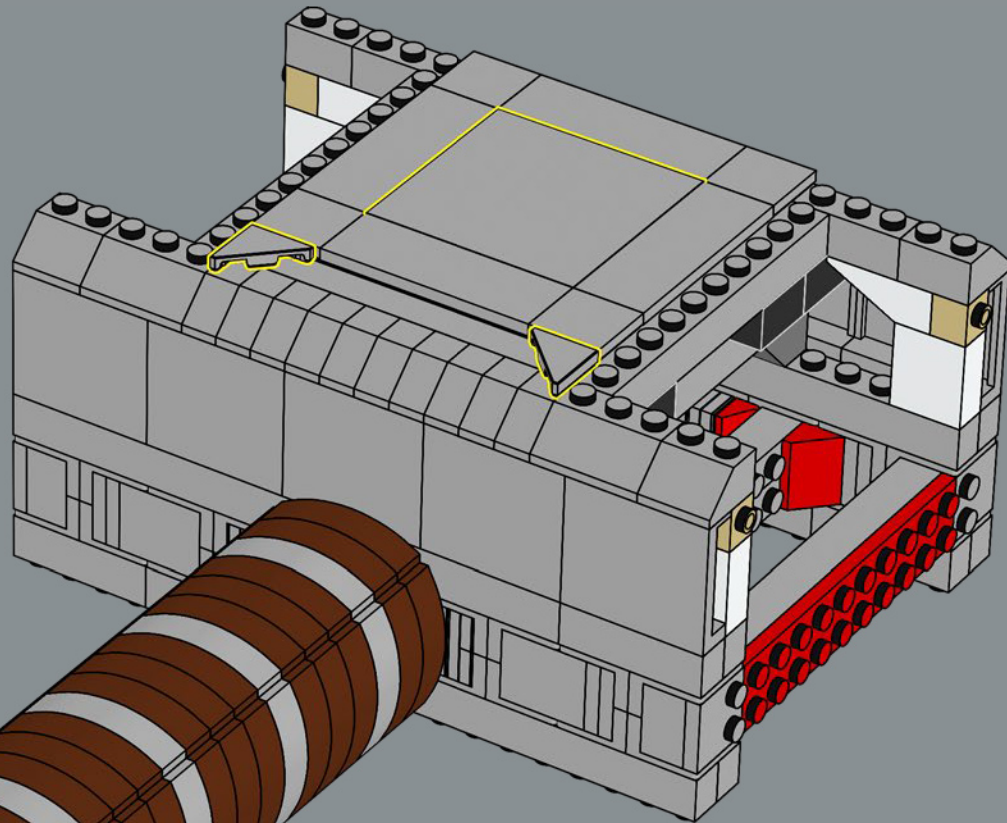

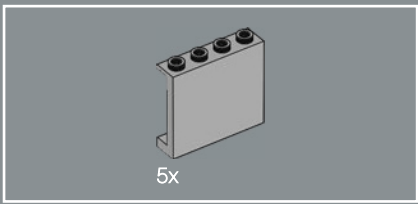

84

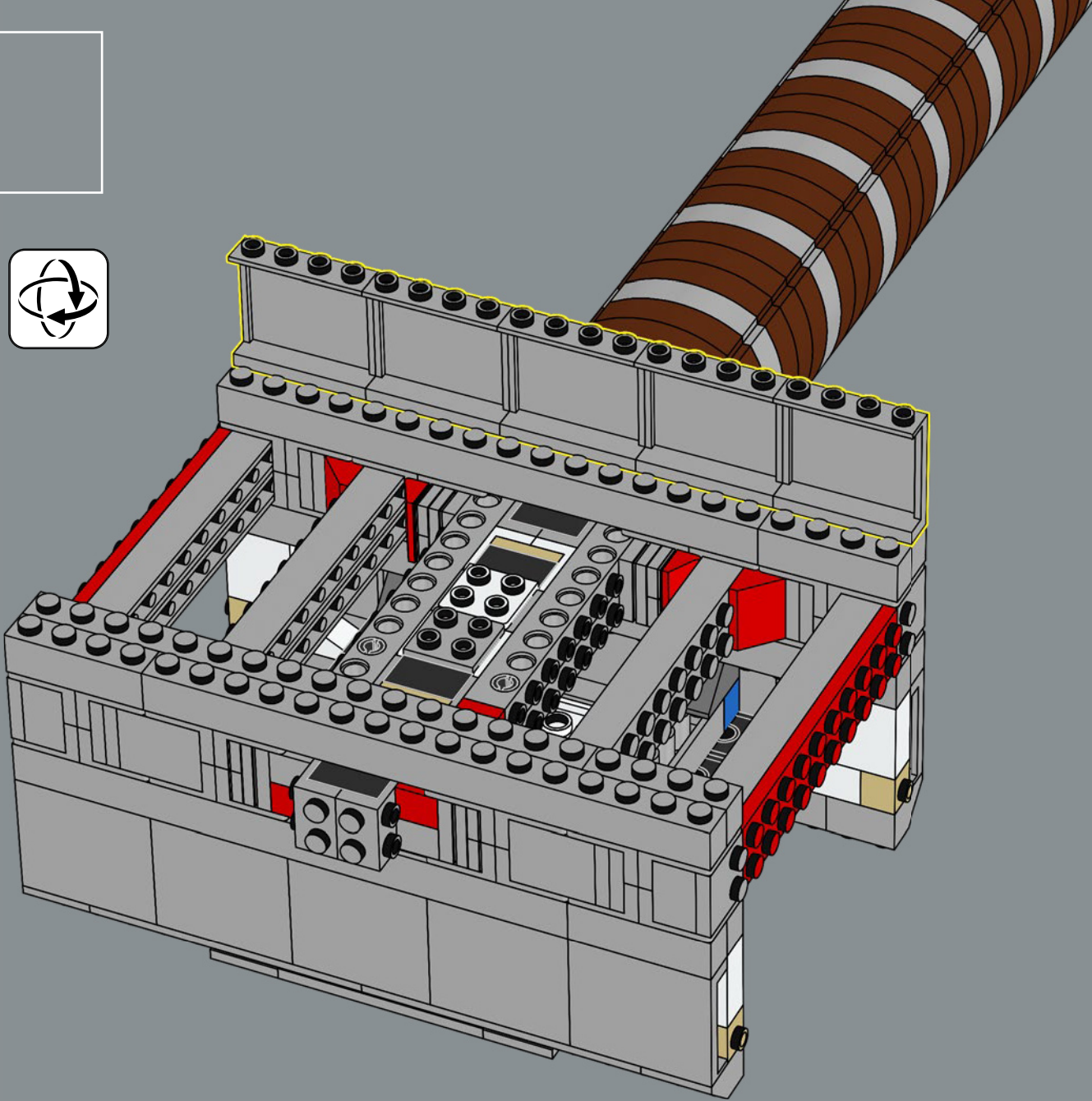

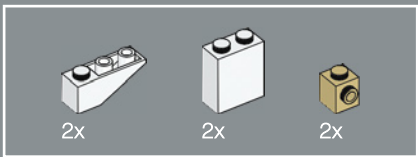

85

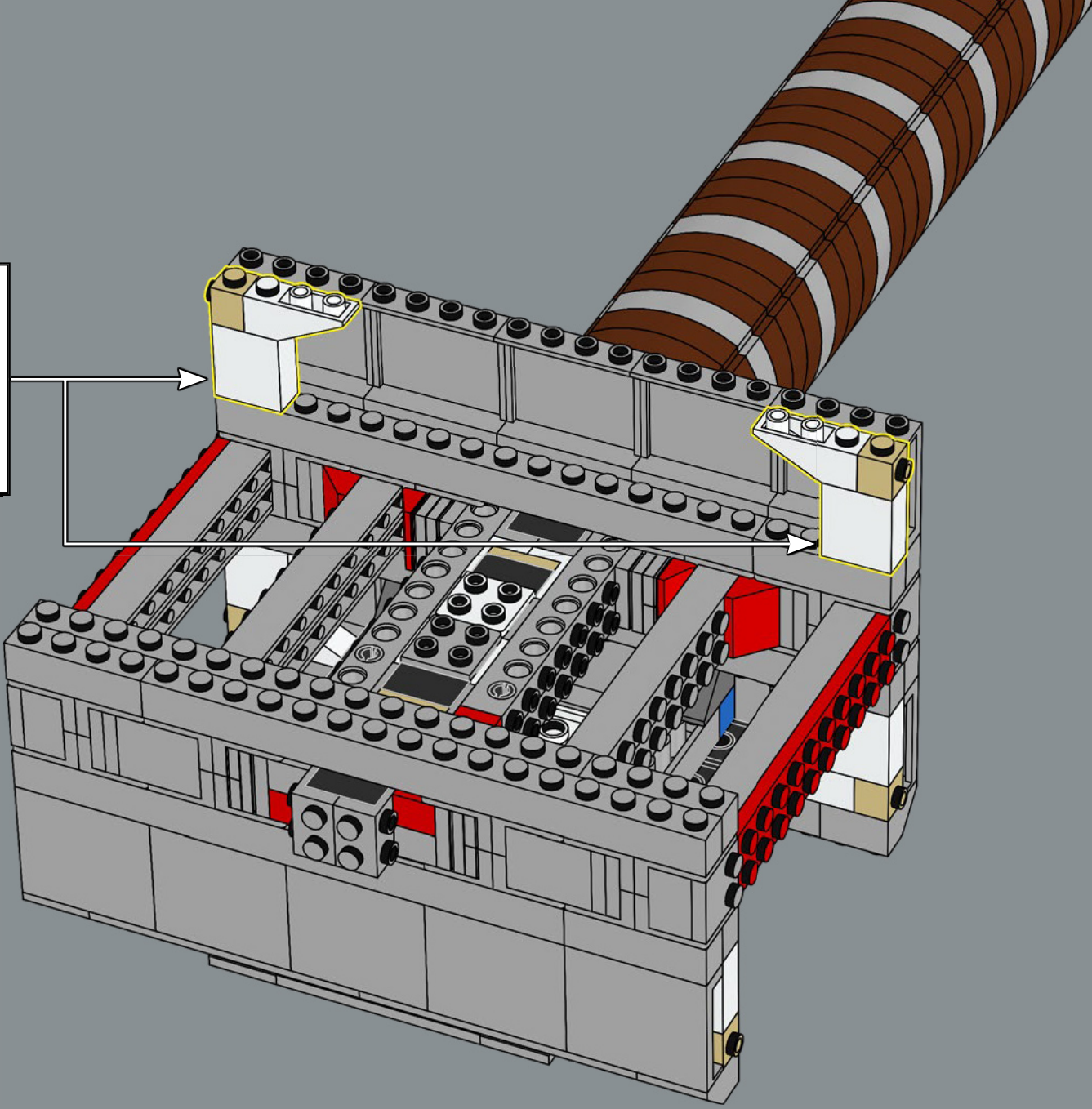
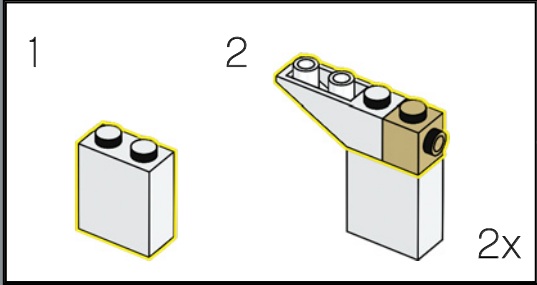

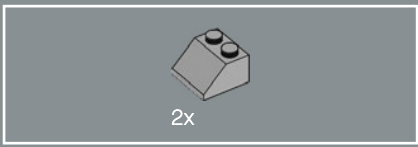

86

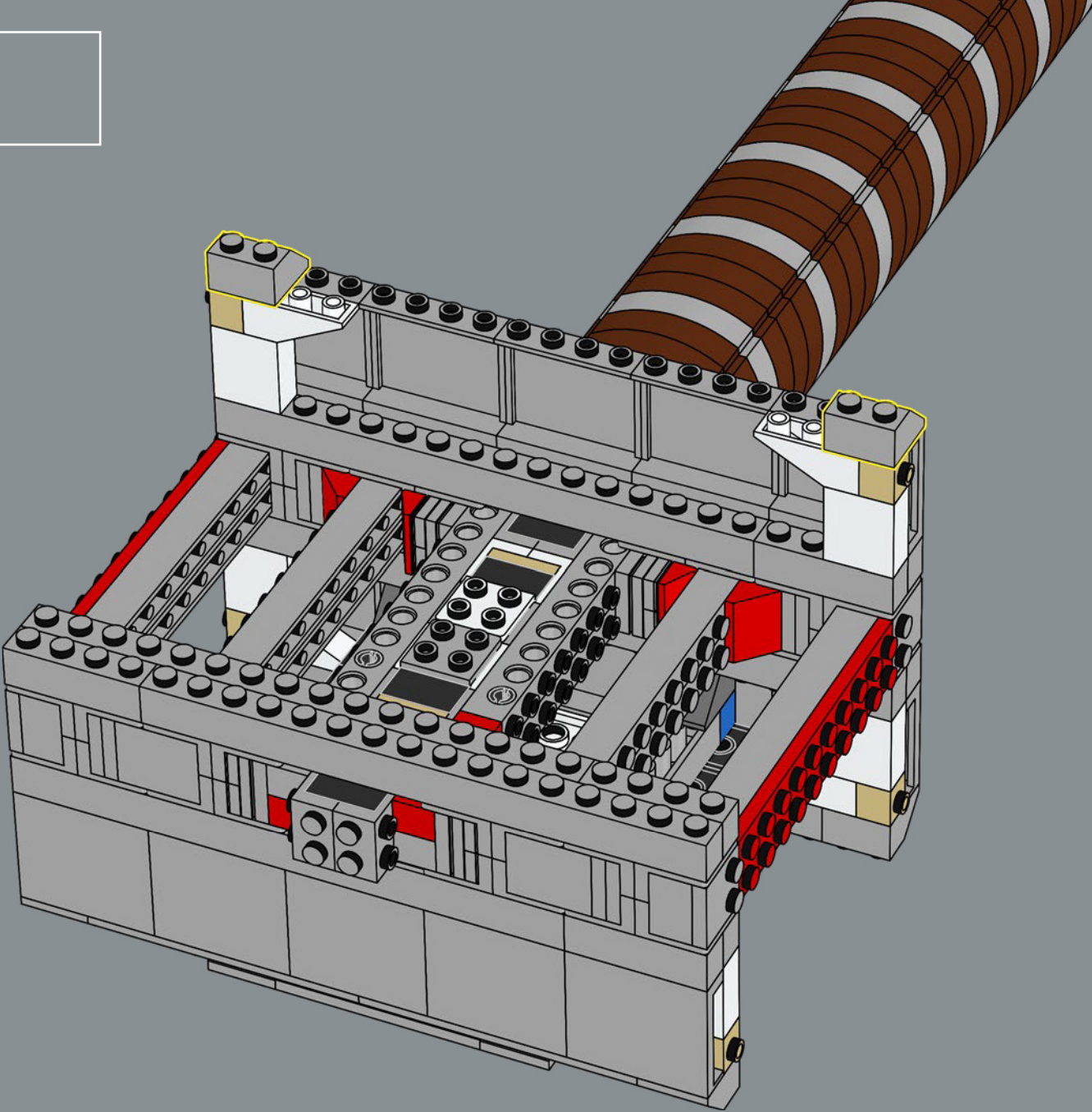

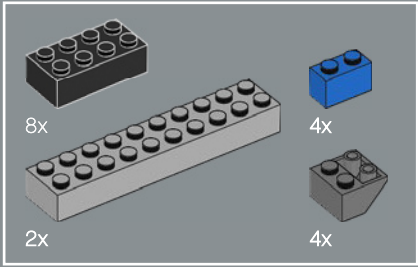
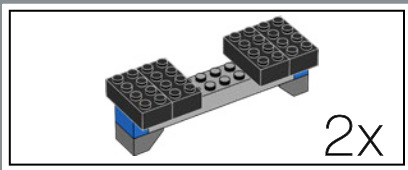

87

1

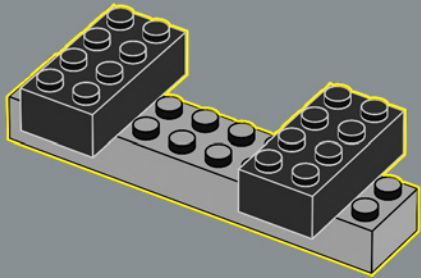

2

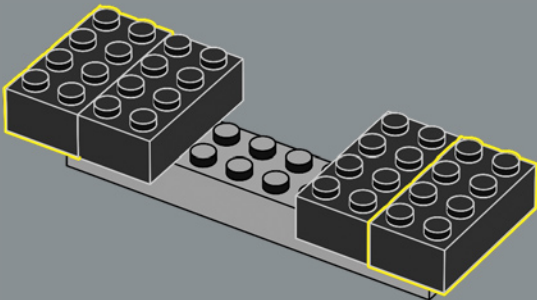

3

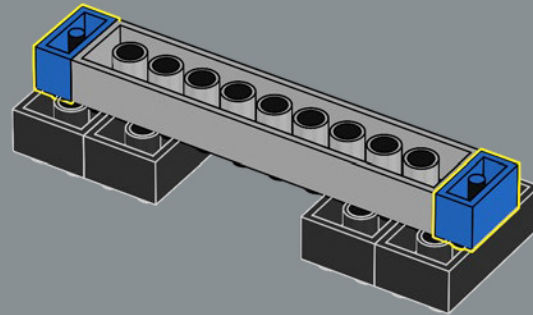

4

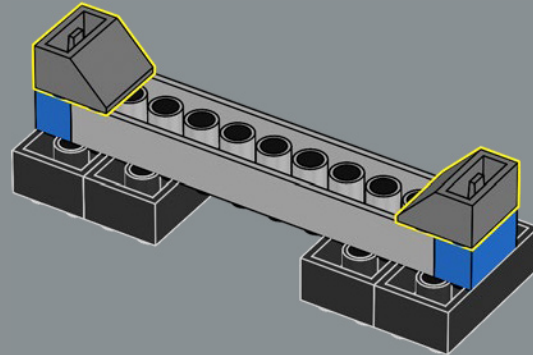

2x

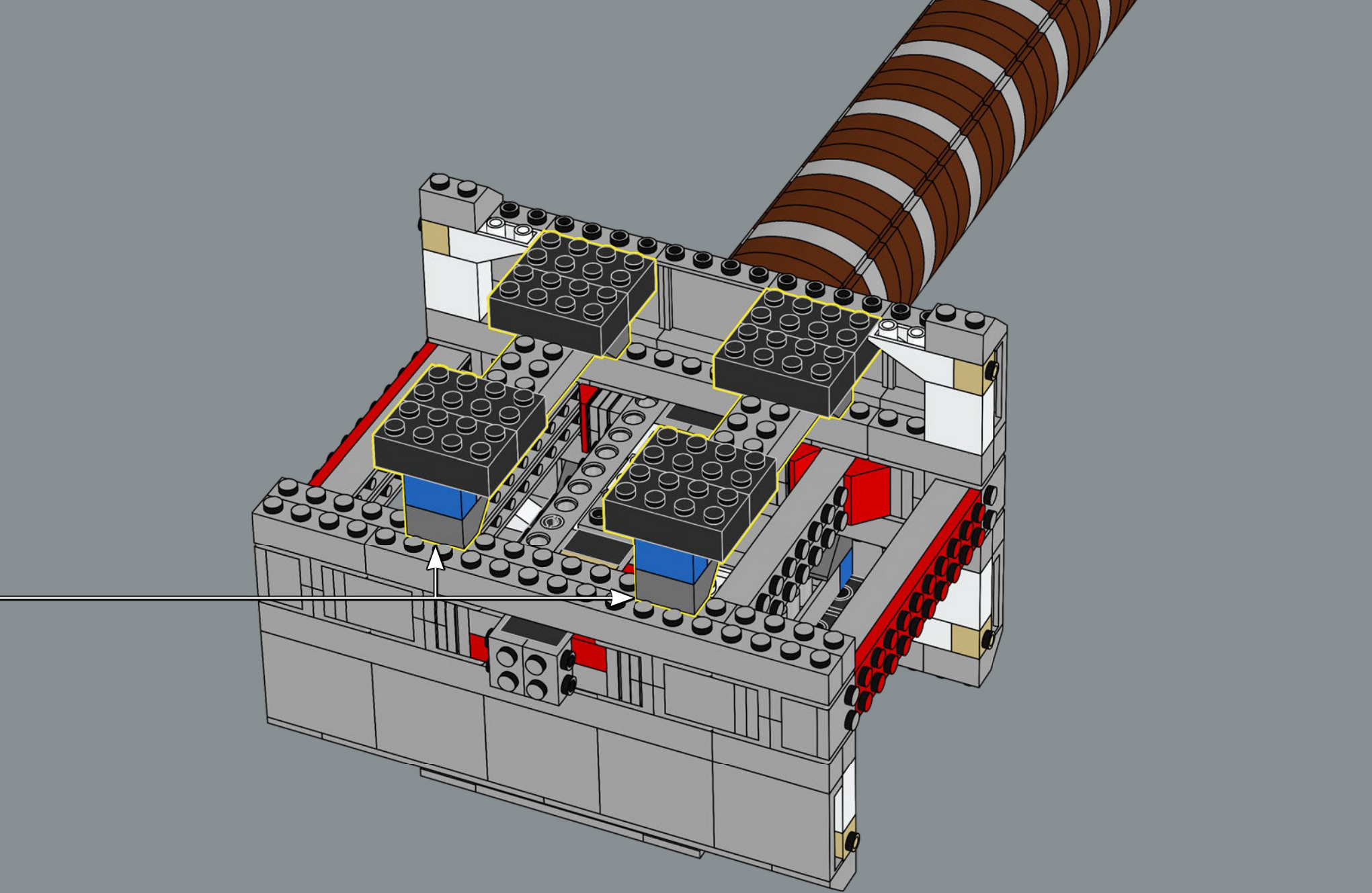

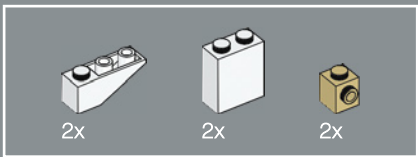

88

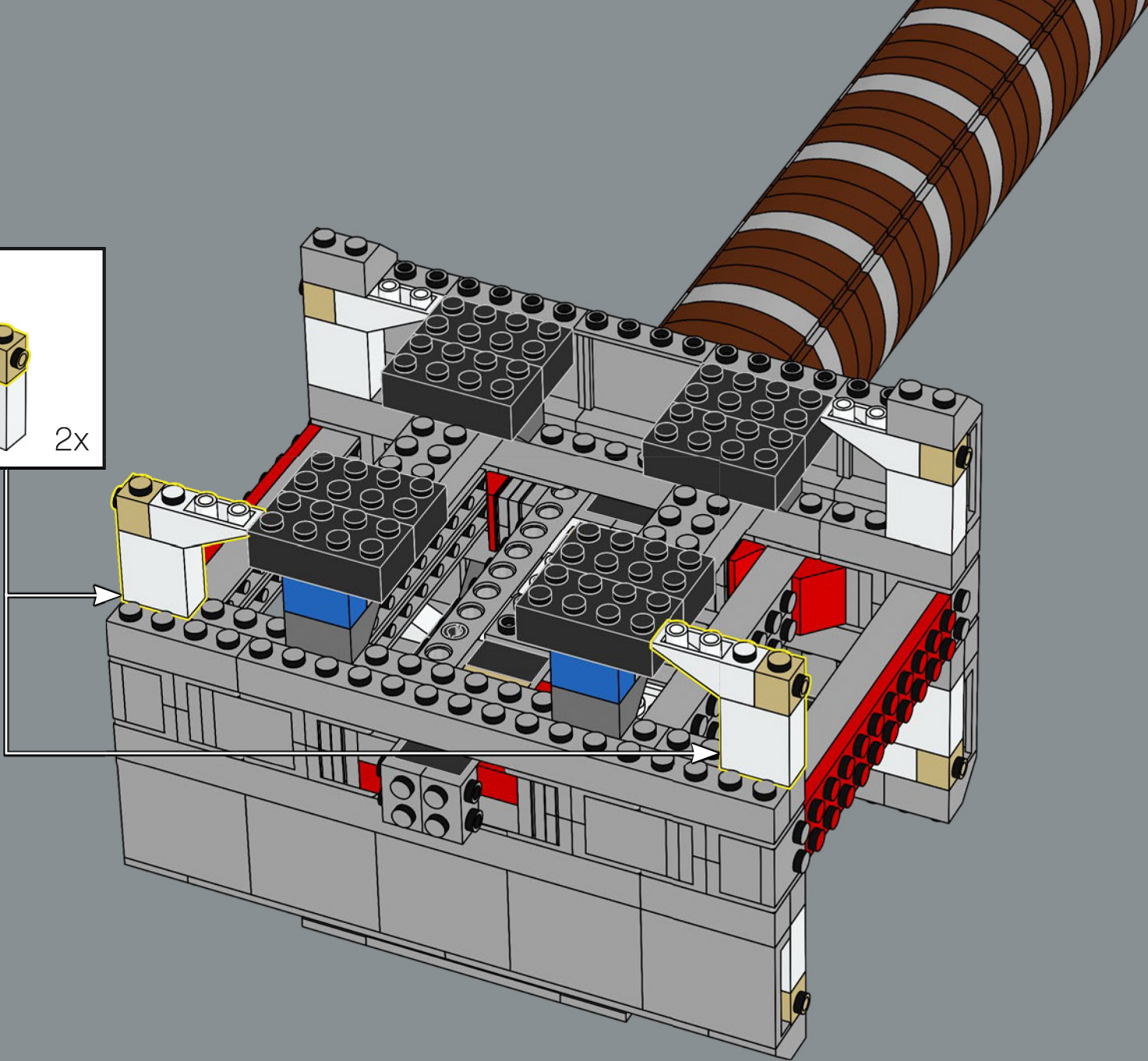
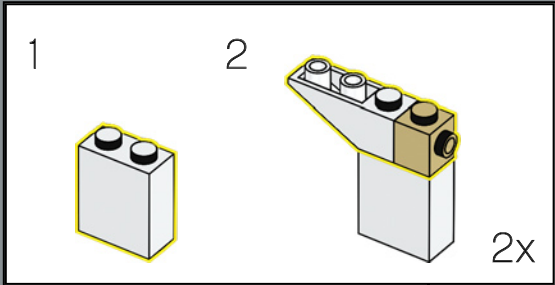

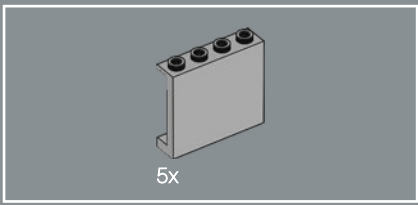

89

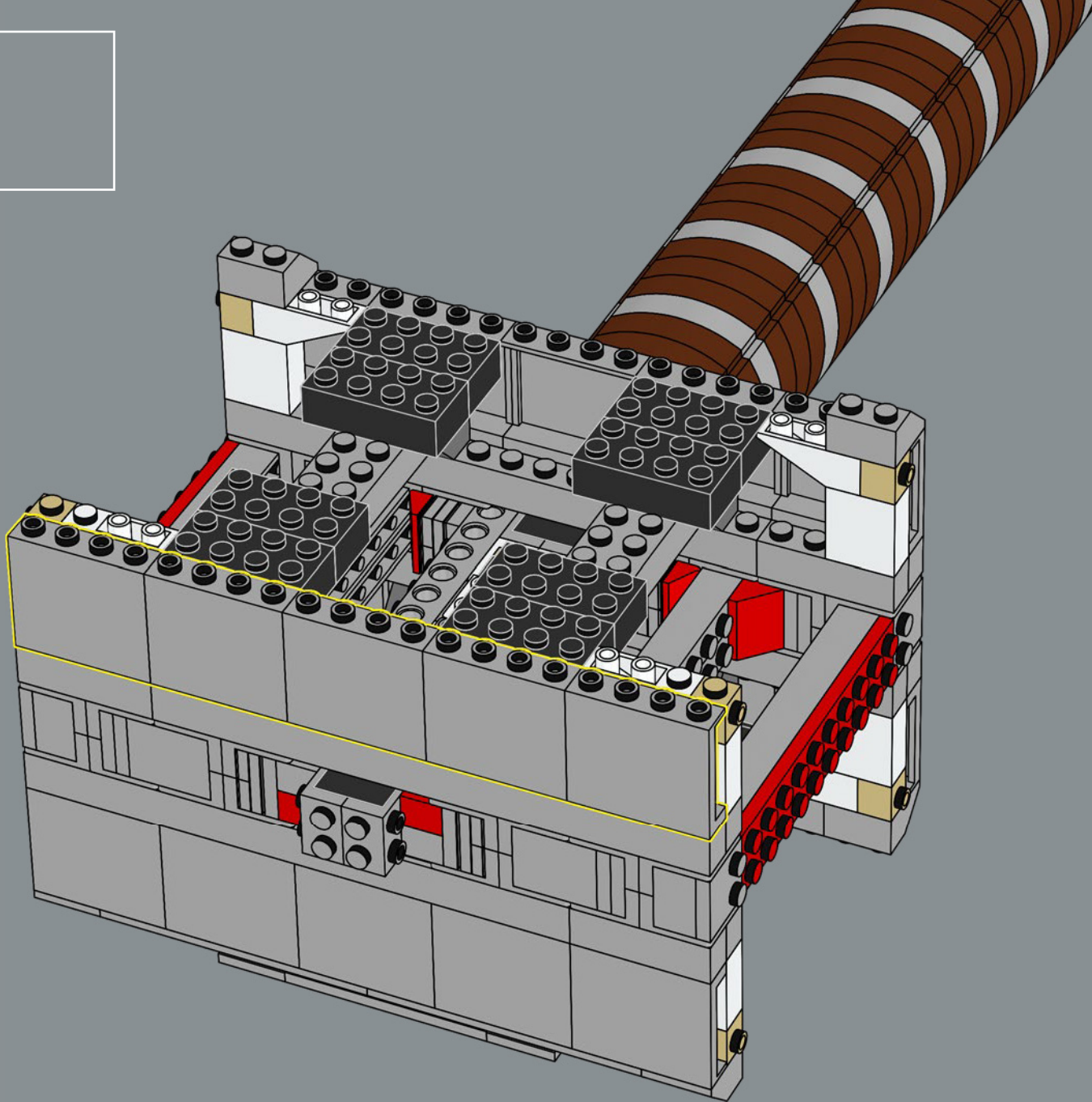

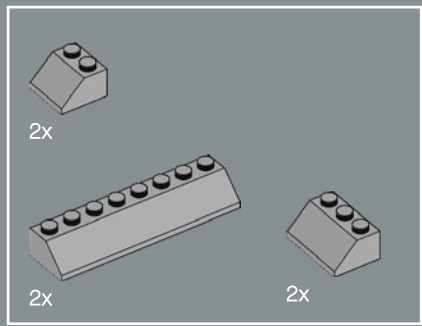

90

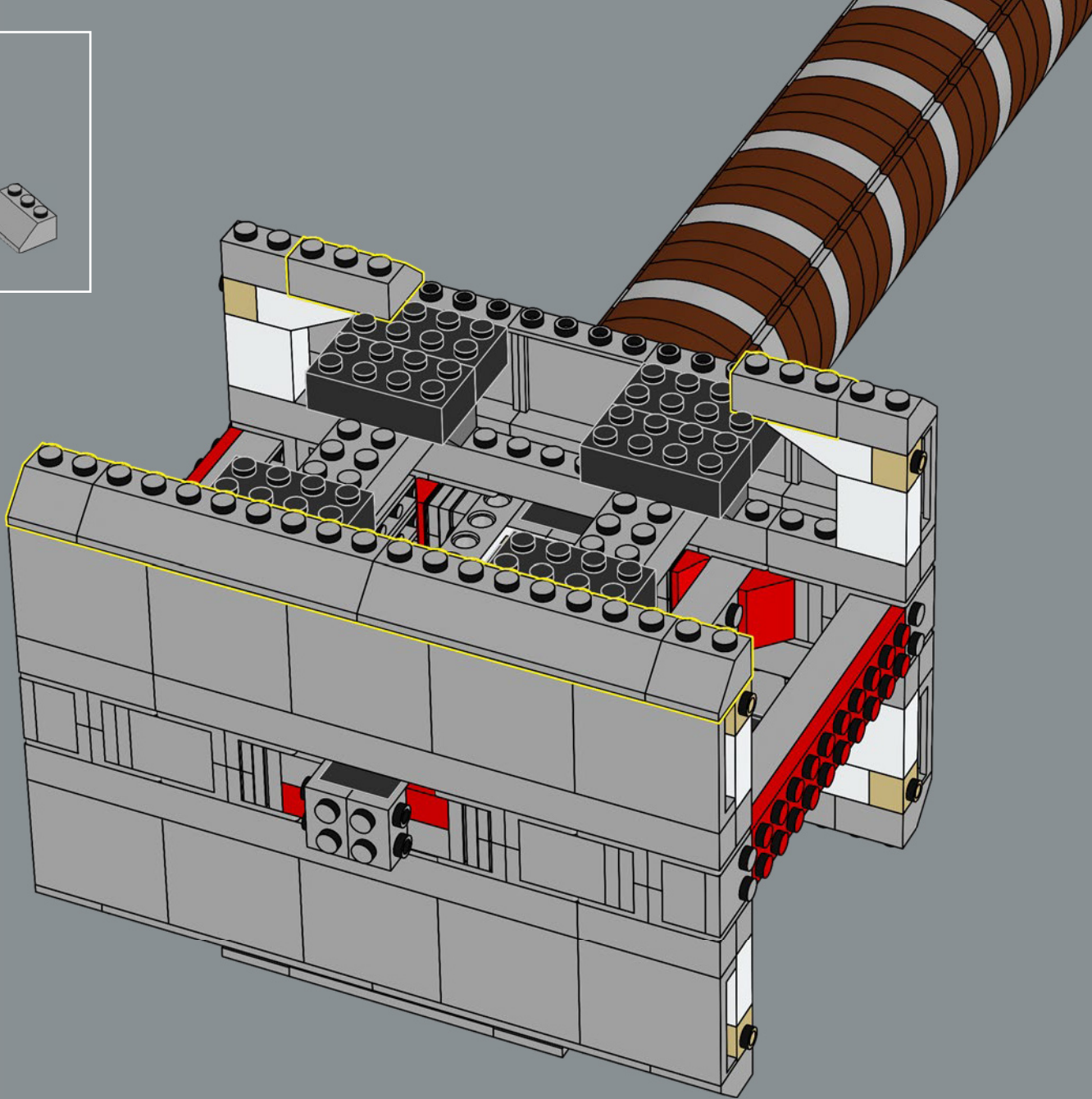

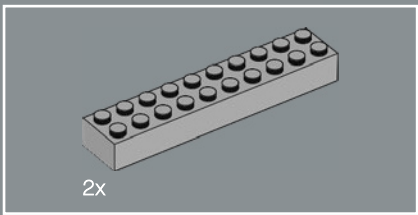

91

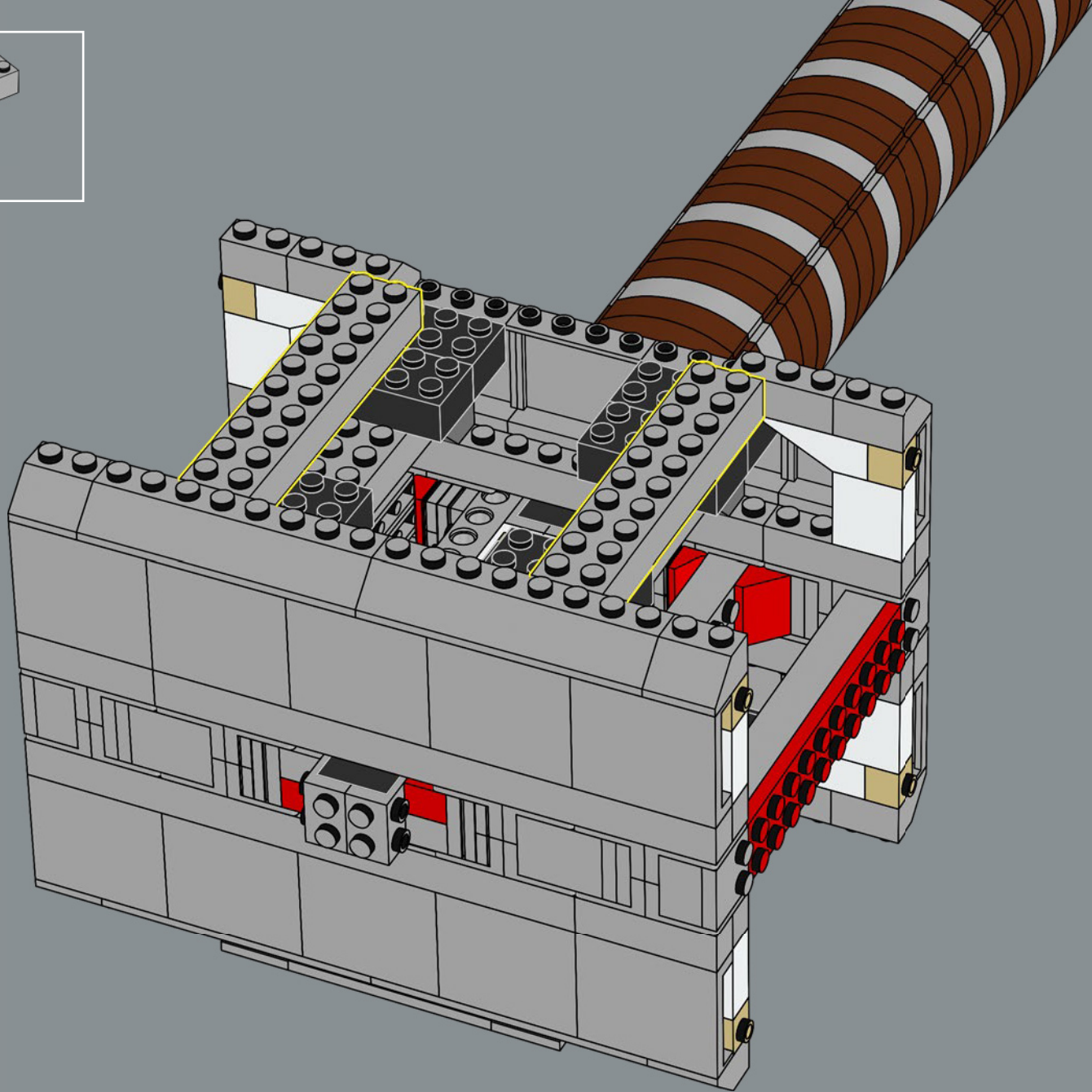

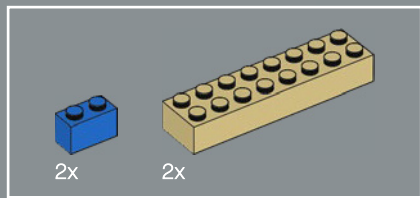

92

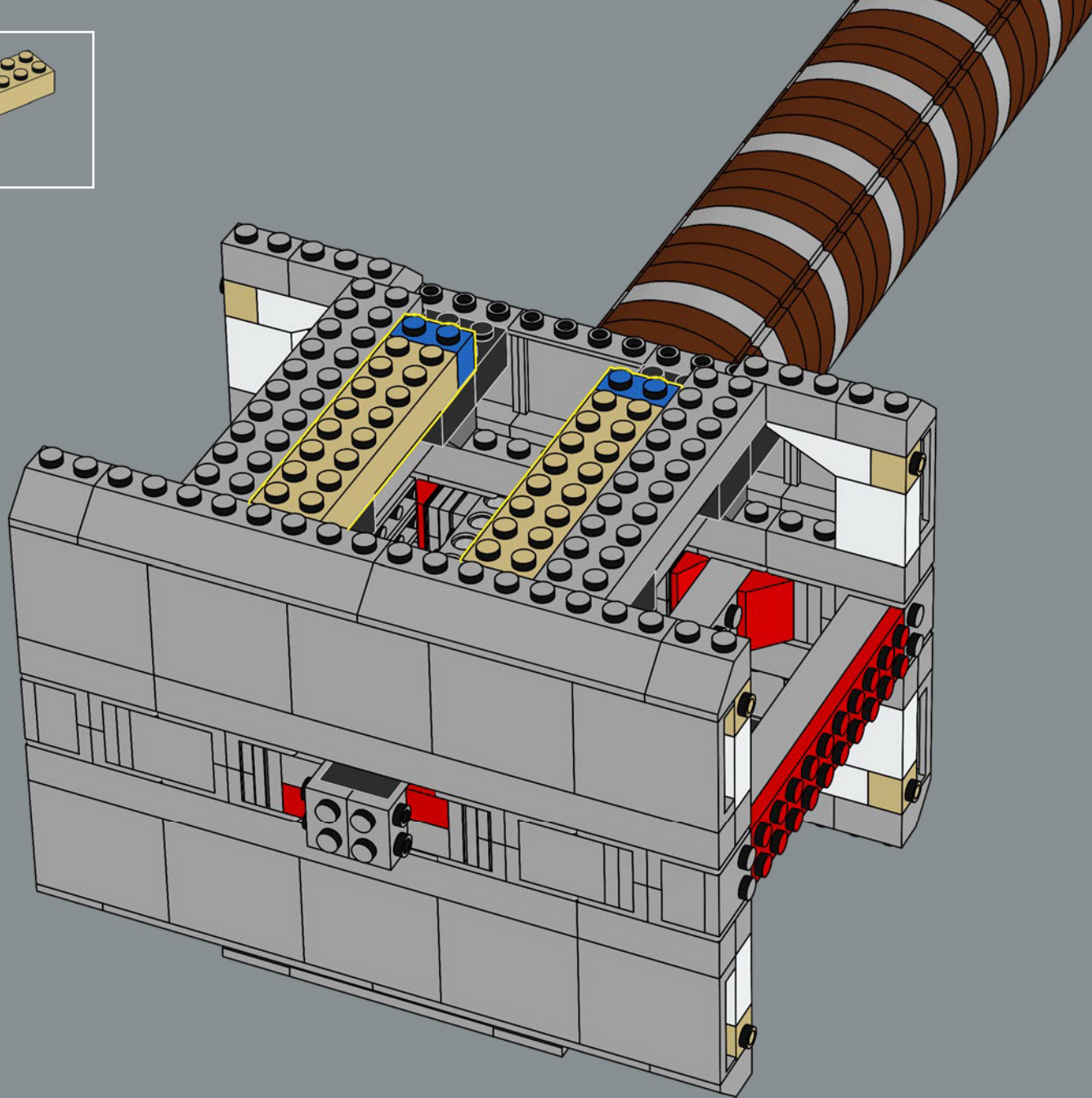

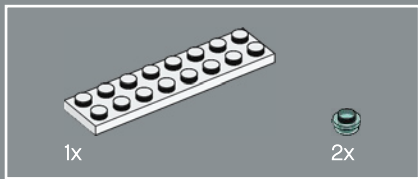

93

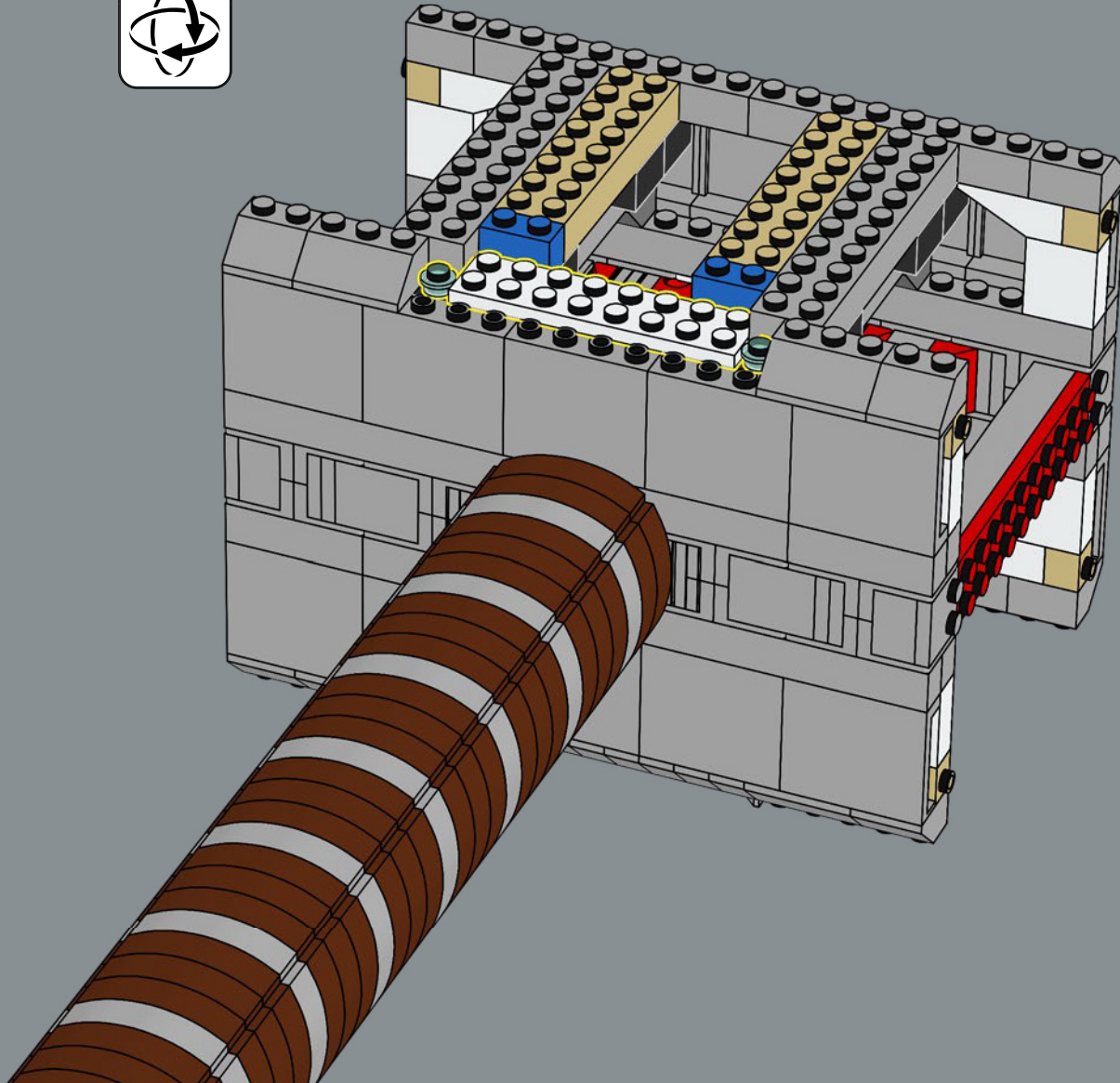

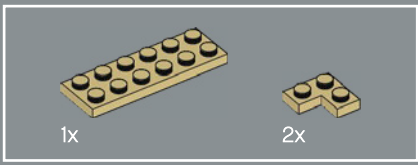

94

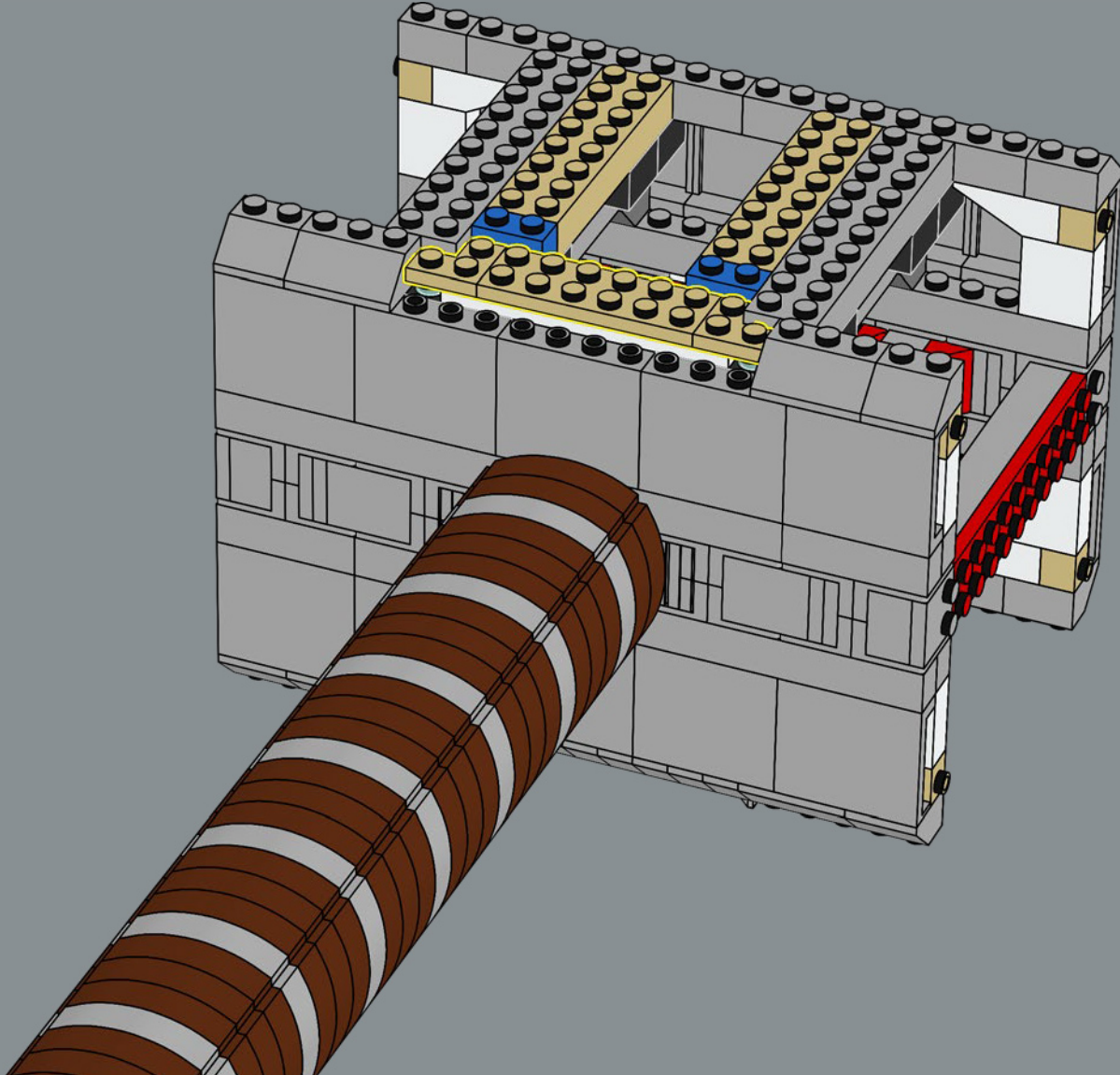

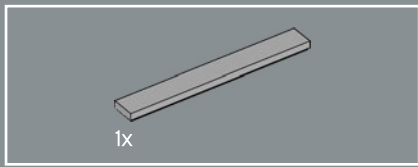

95

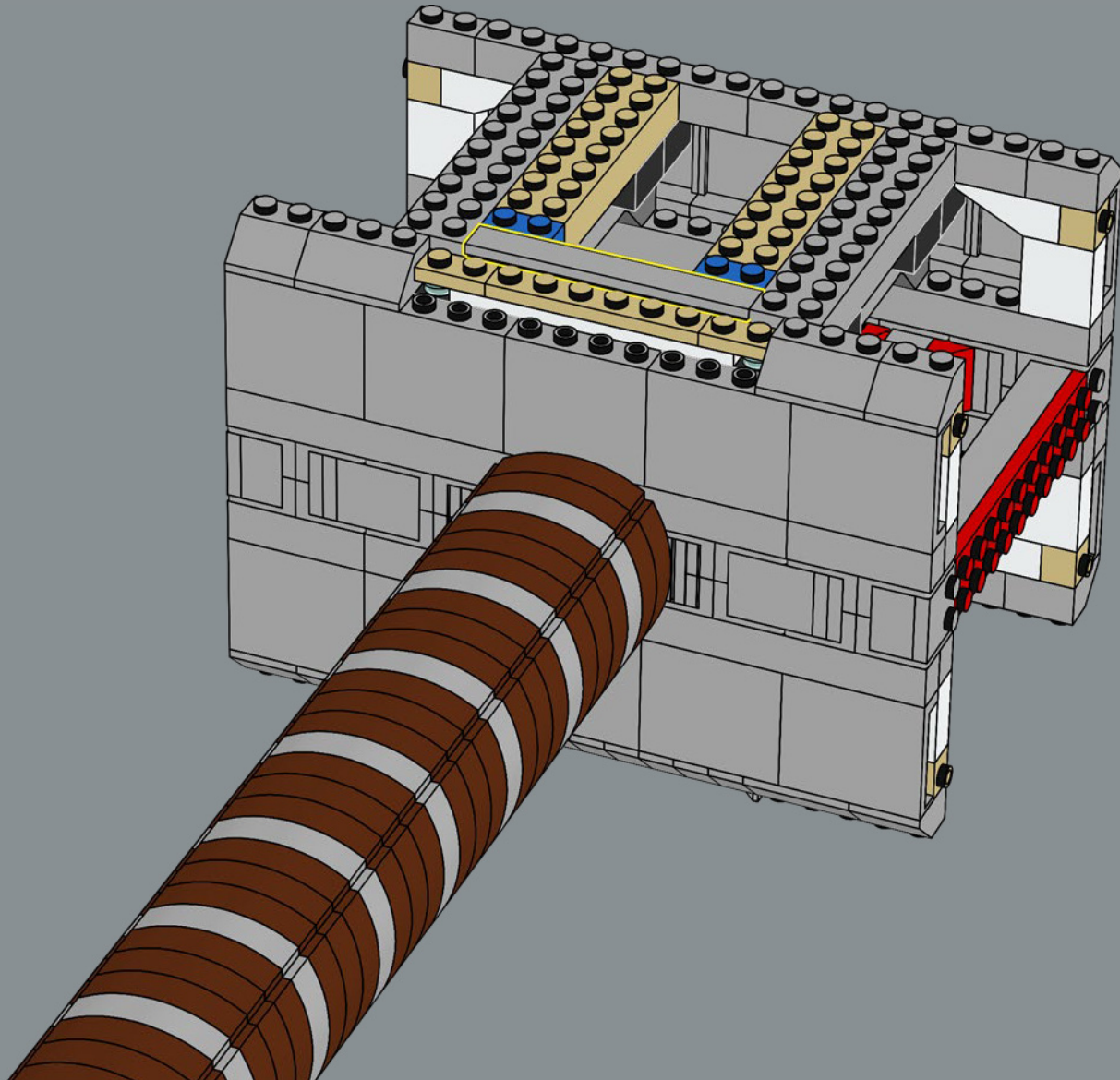



10x

96

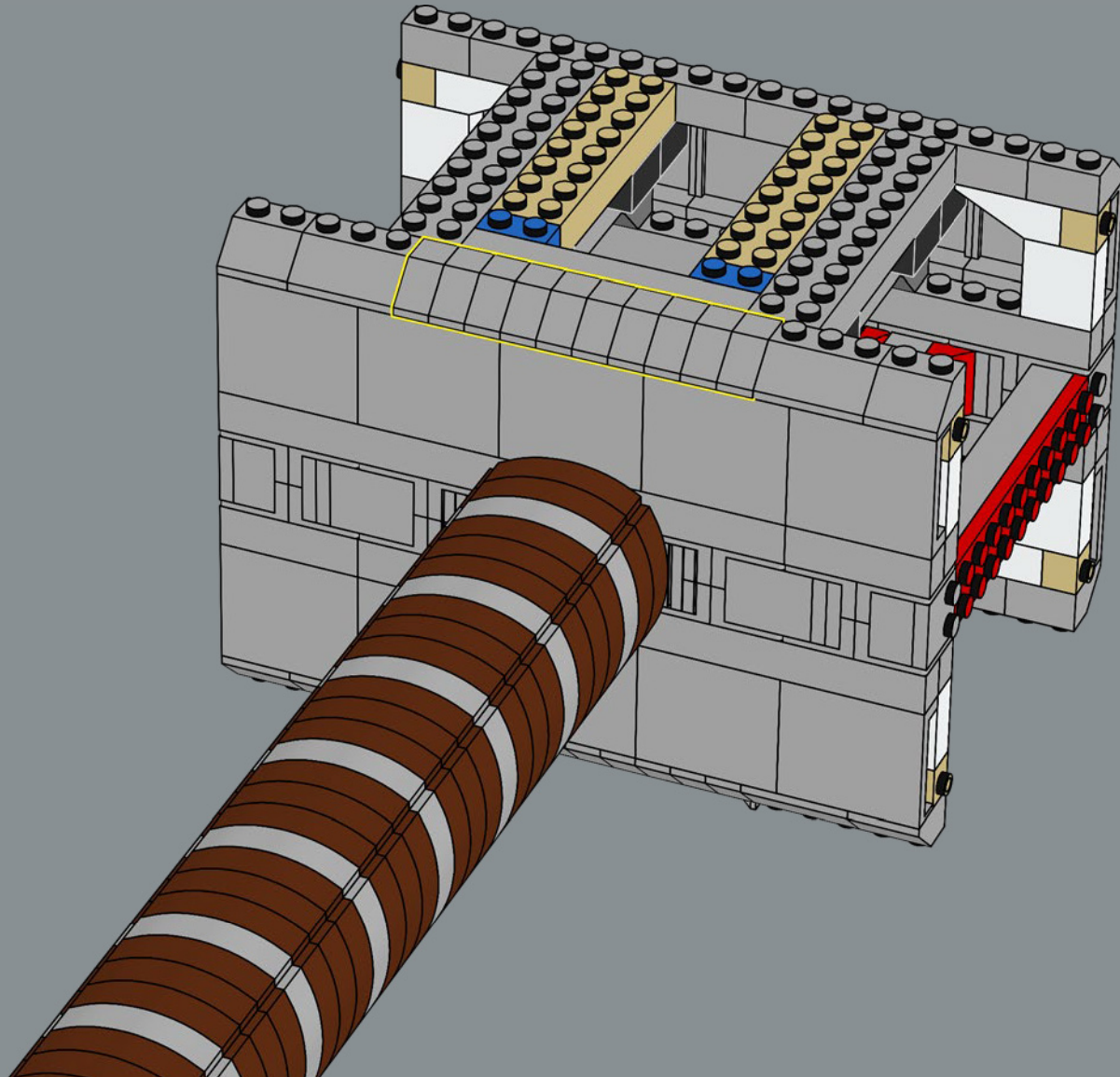

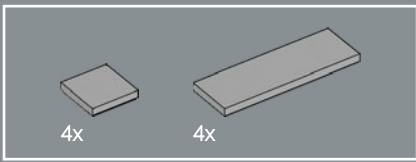

97

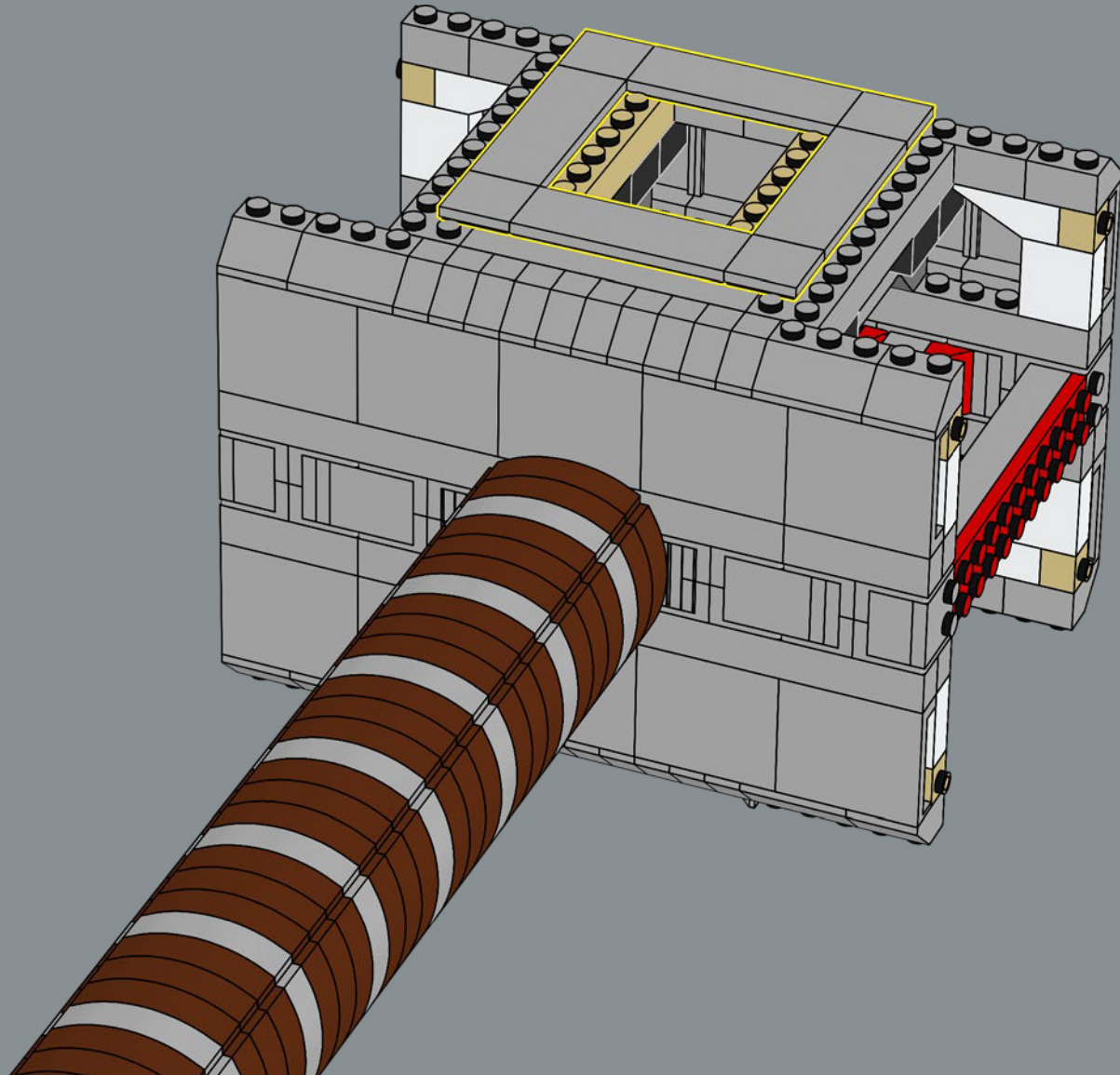

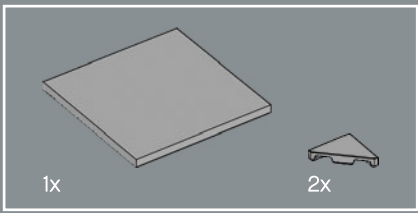

98

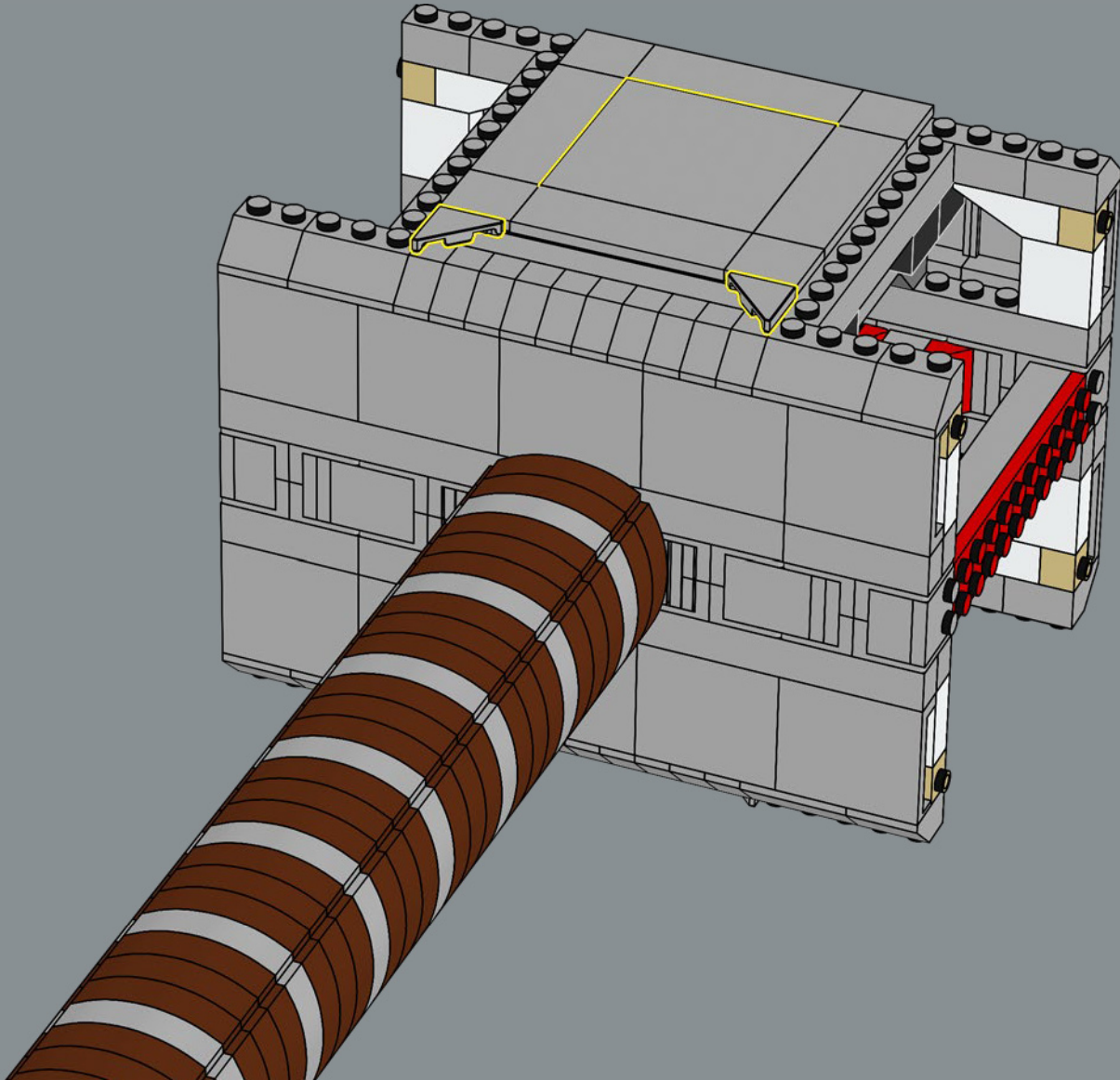

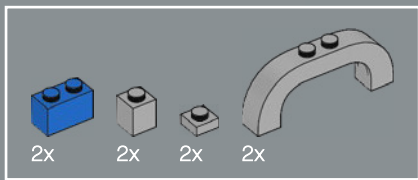

99

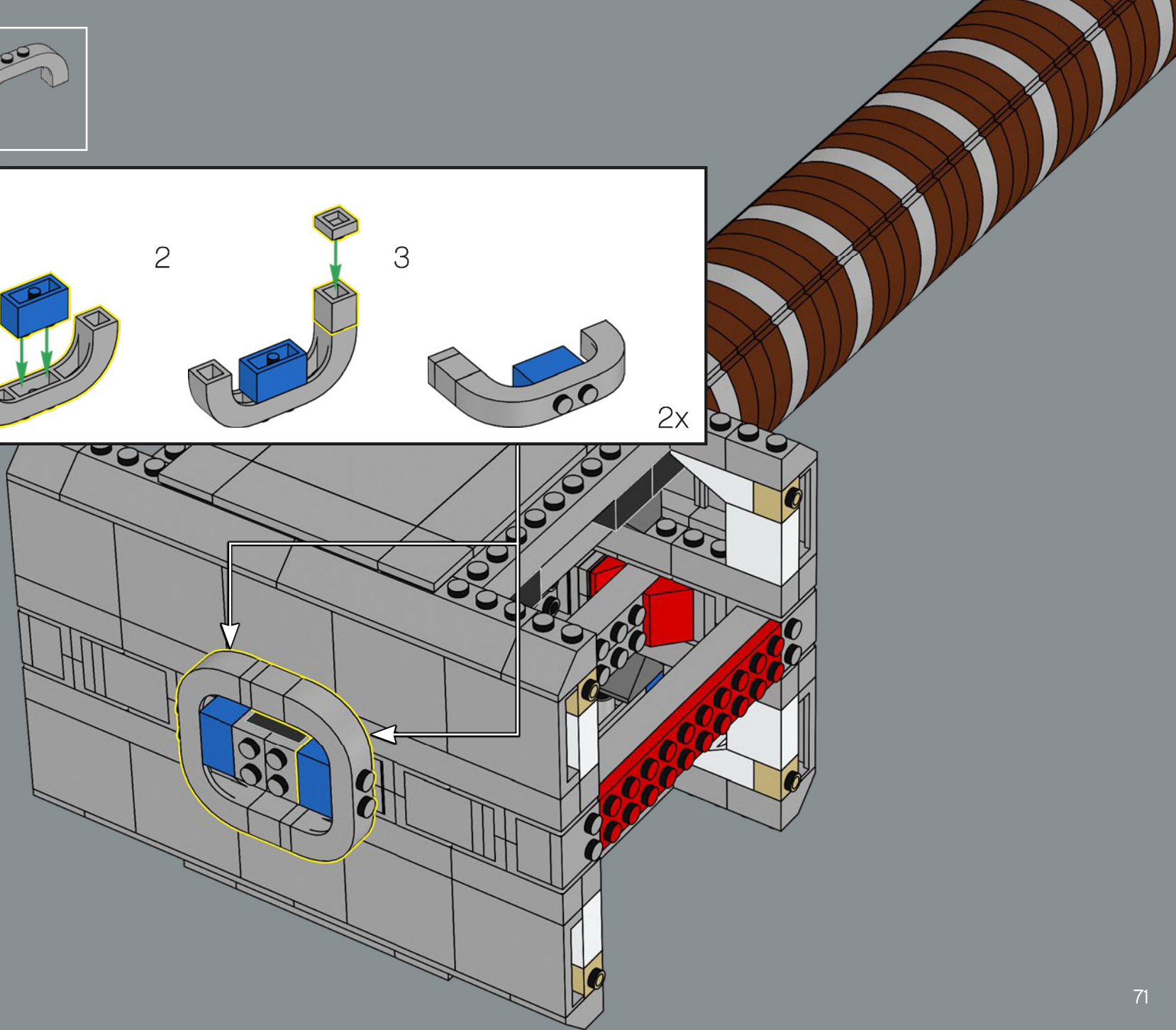
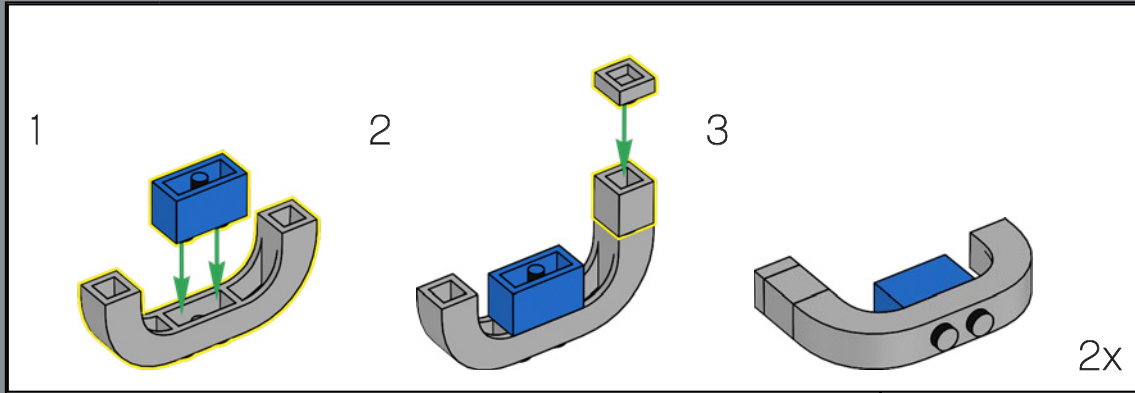

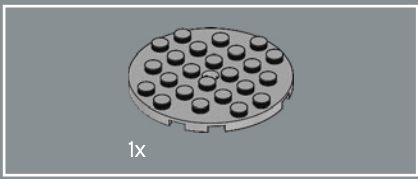

100

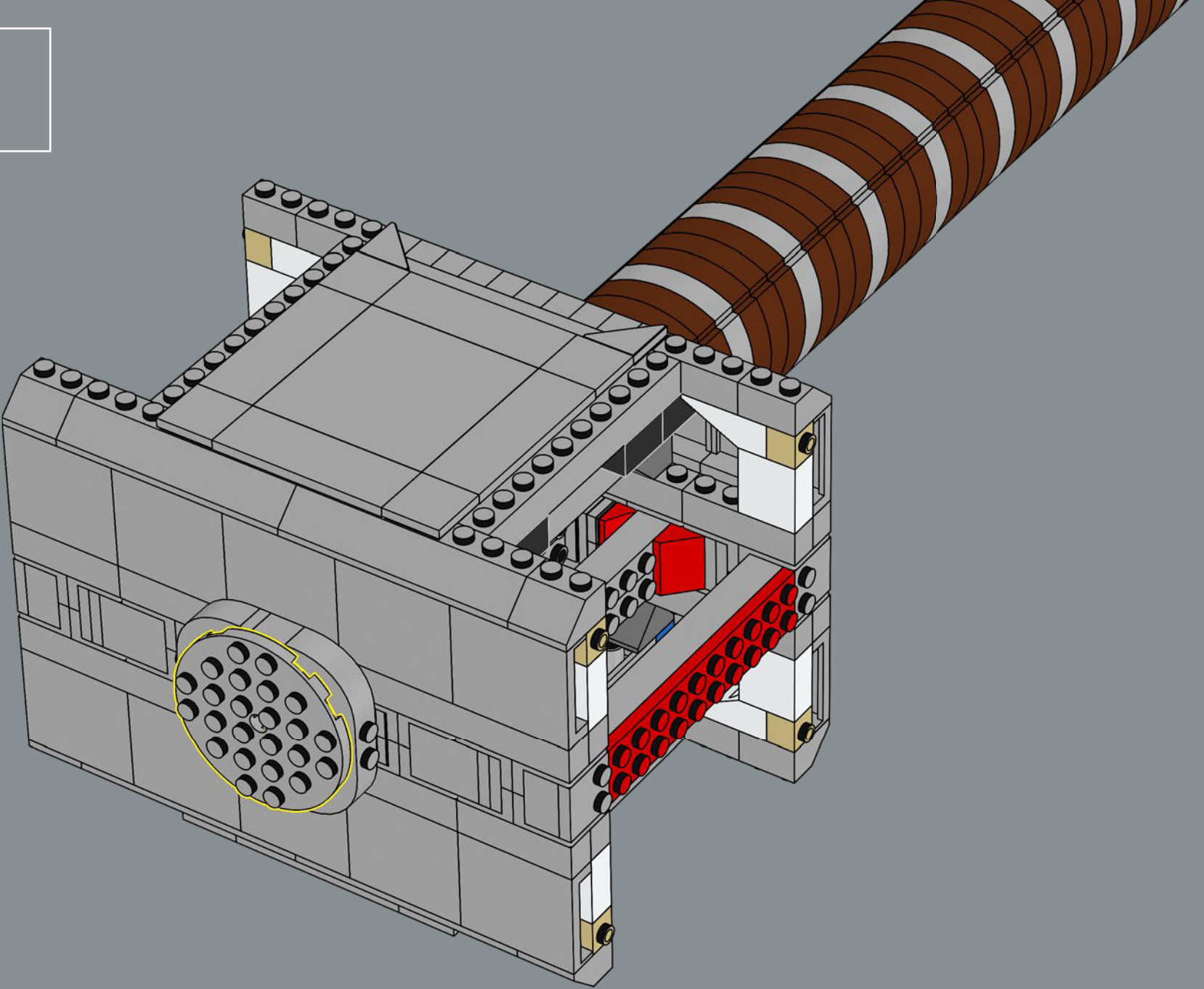

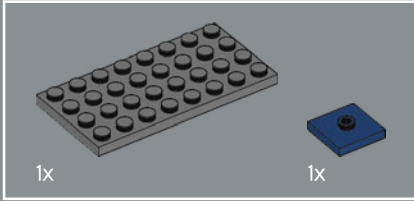

101

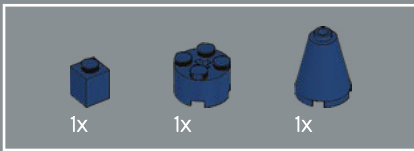
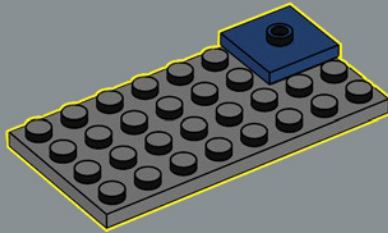

102

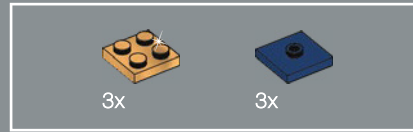
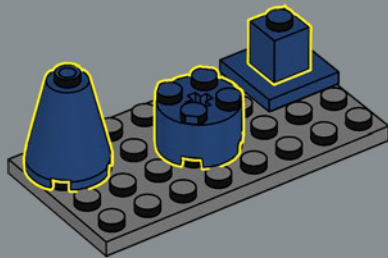

103

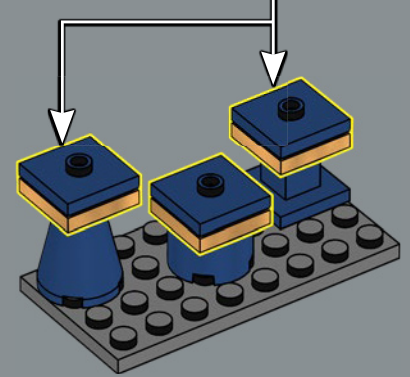
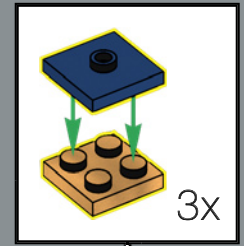

104

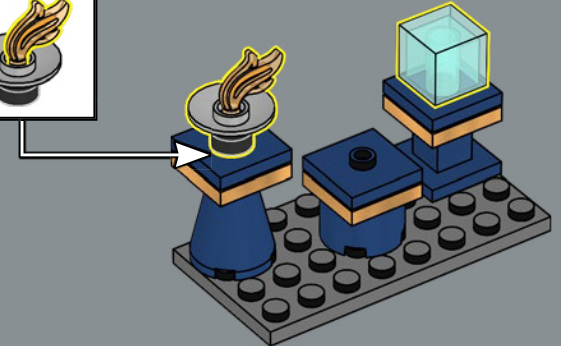
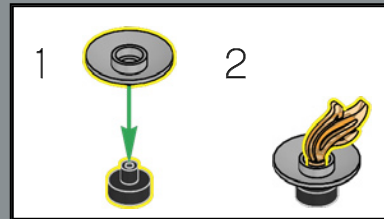



2x

105

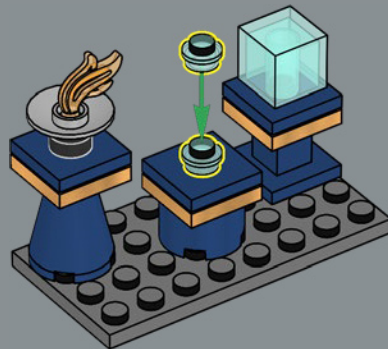

1x

1x

1x

1x

1x

1x

1x

106

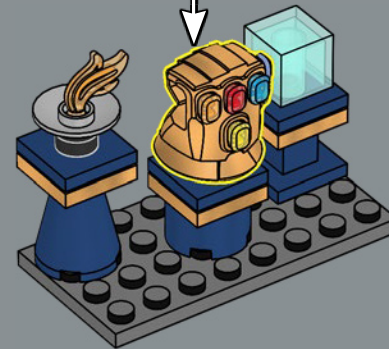
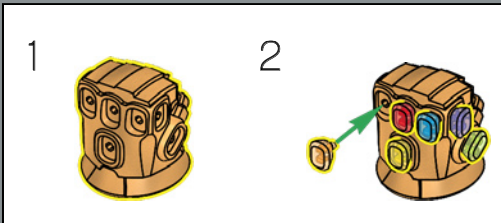

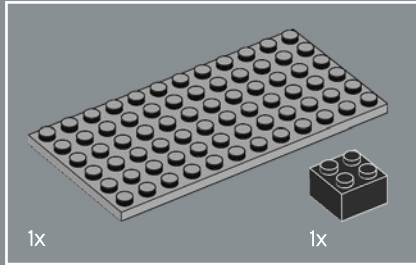
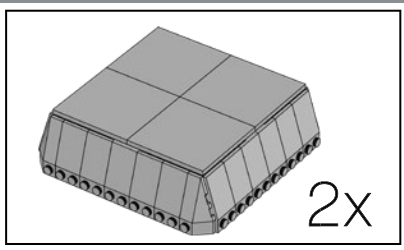
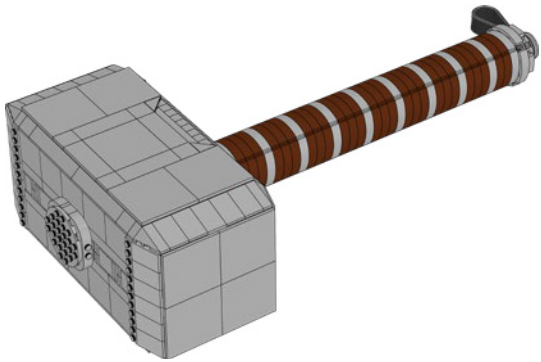

107

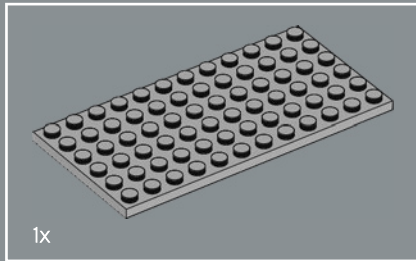
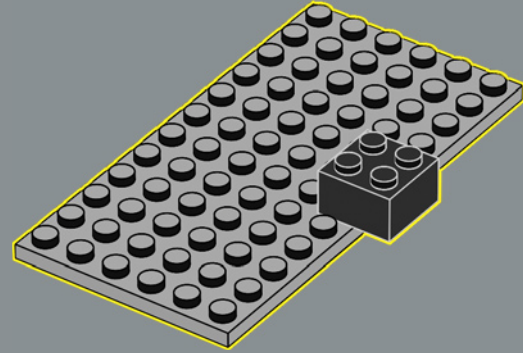

108

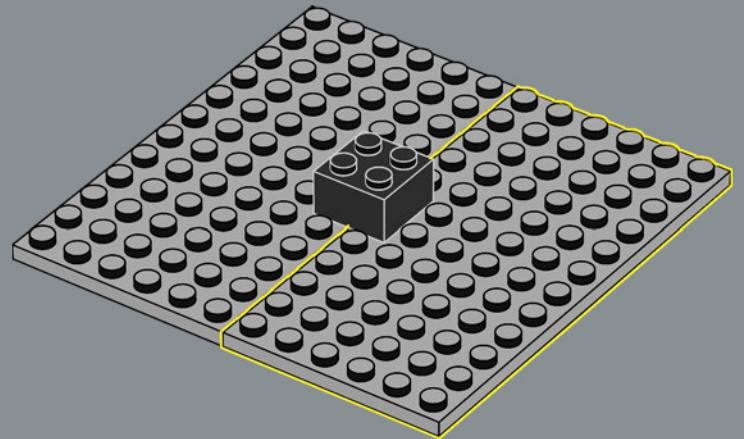

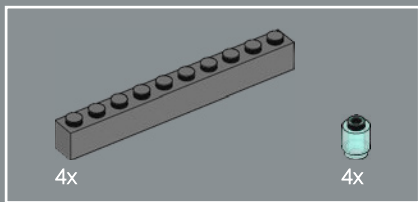

109

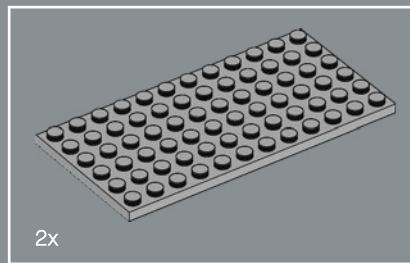
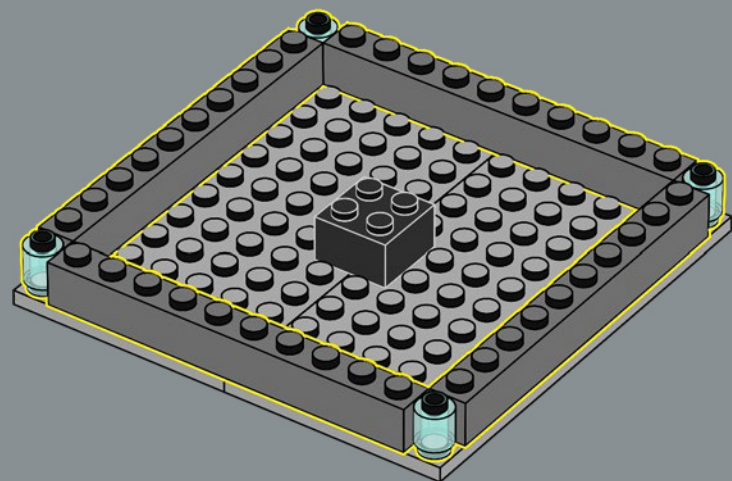

110

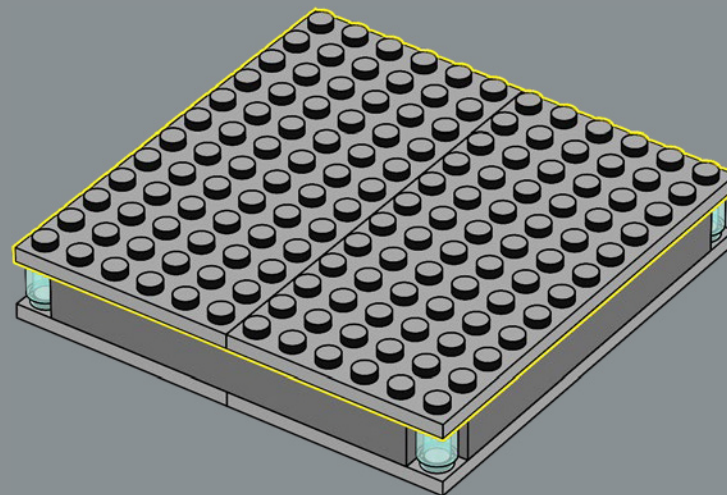

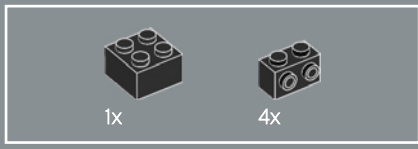

111

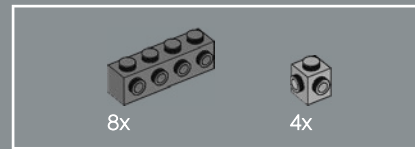
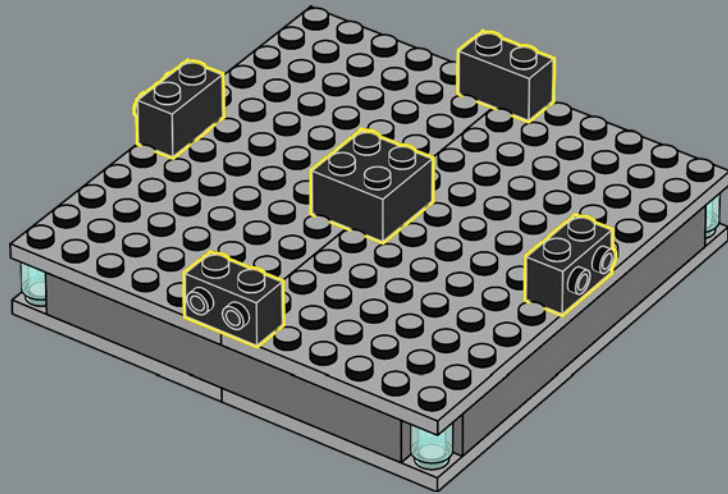

112

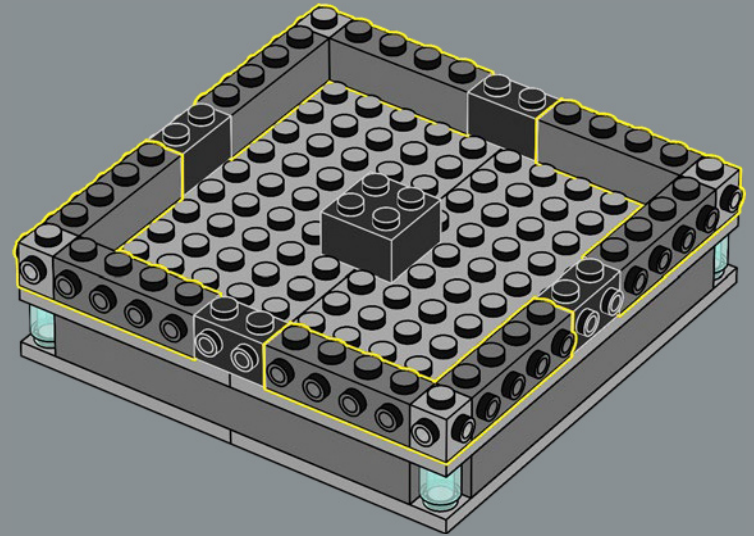

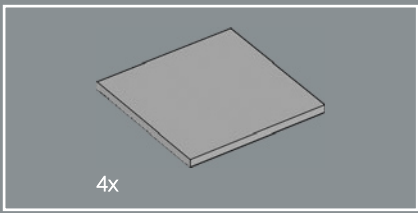

113

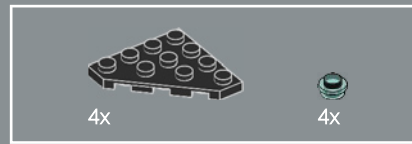
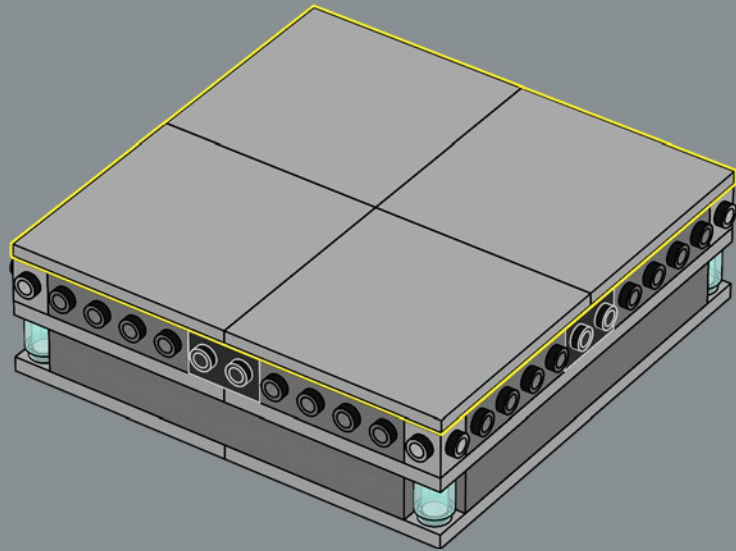

114

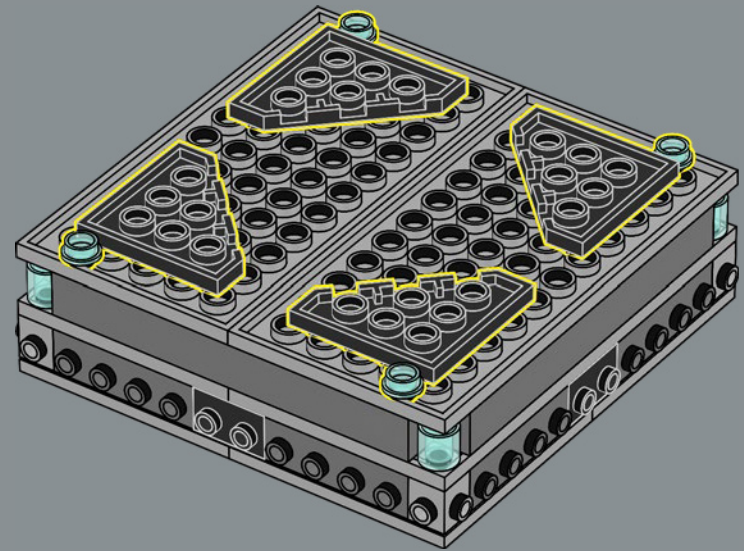



115

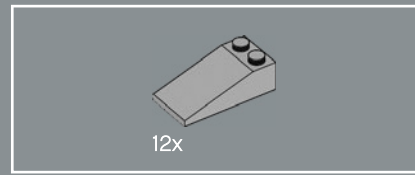
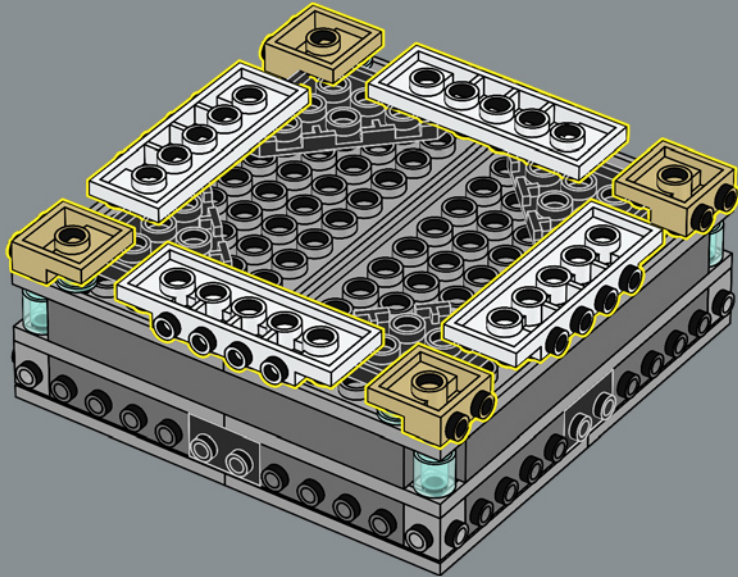

116

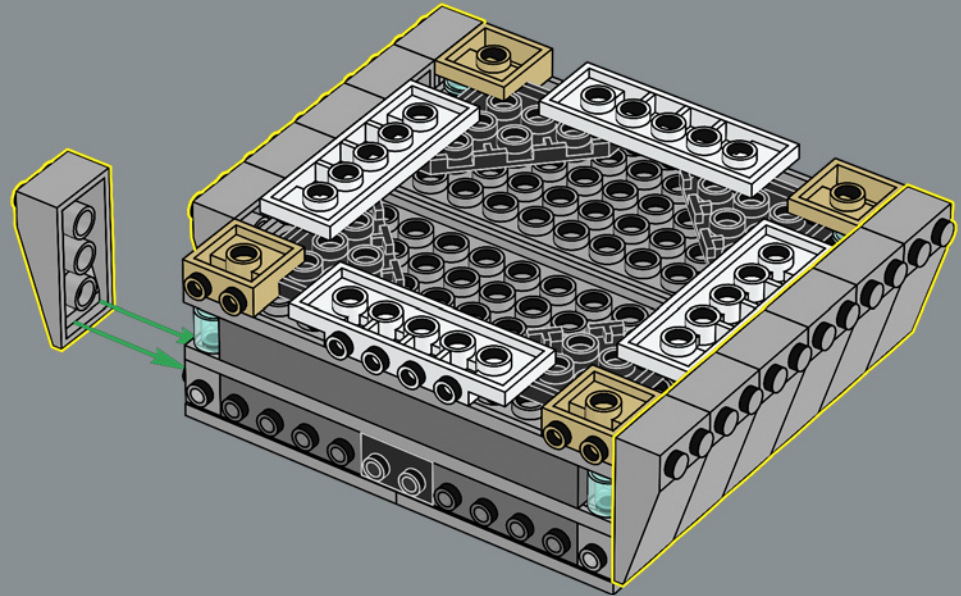

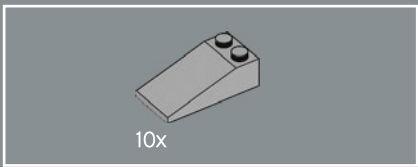

117

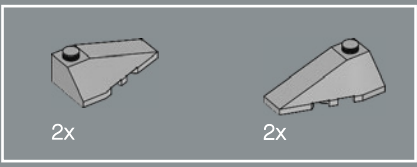
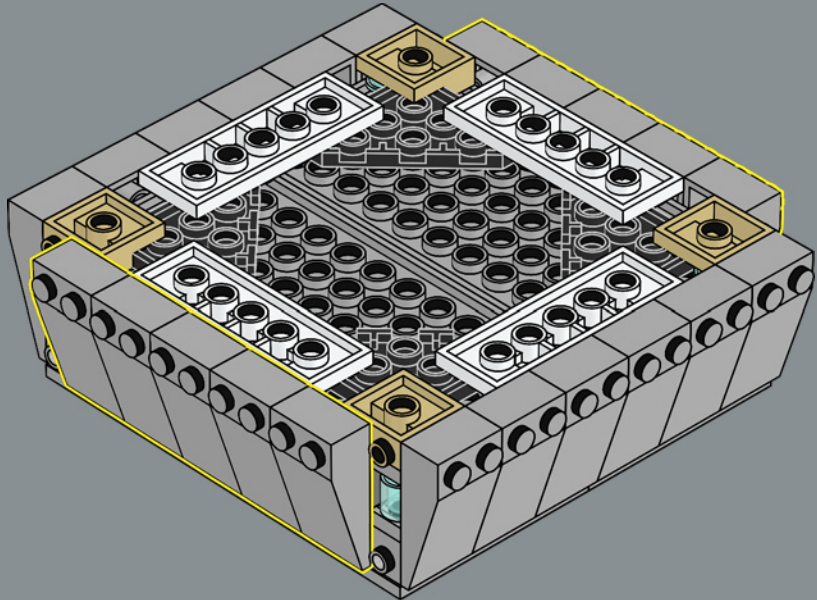

118

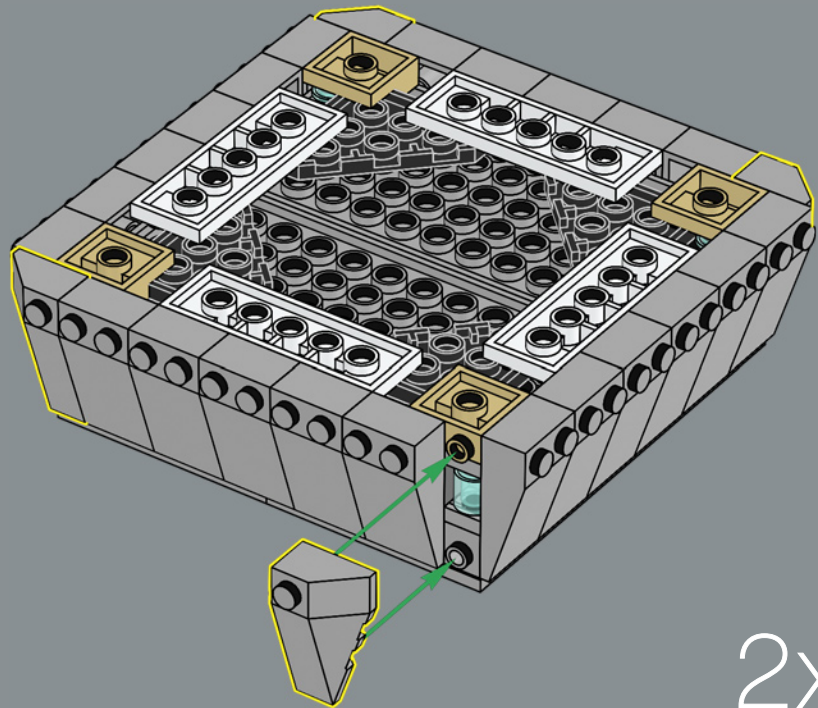

2x

119

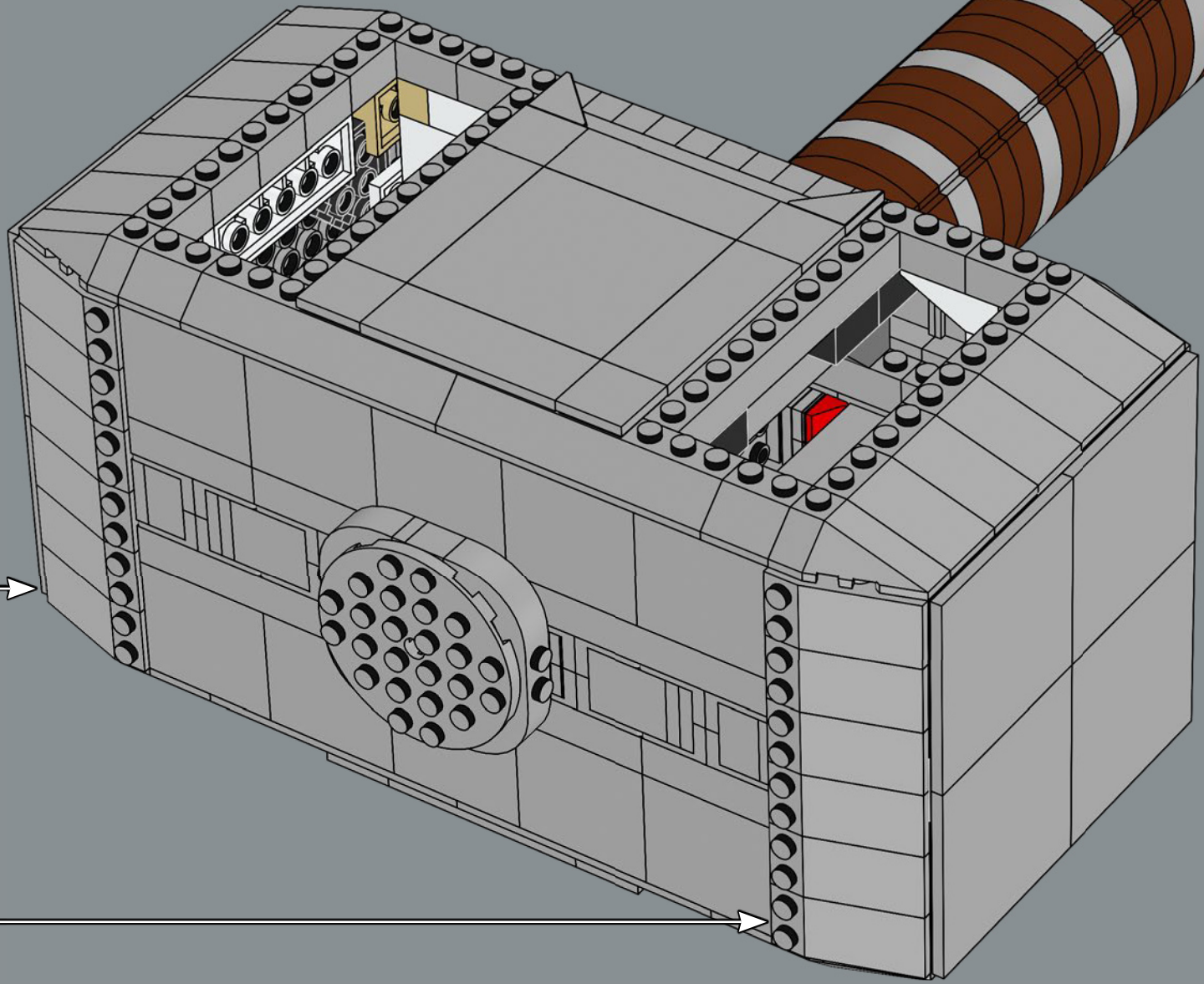

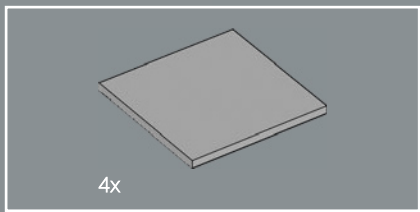

120

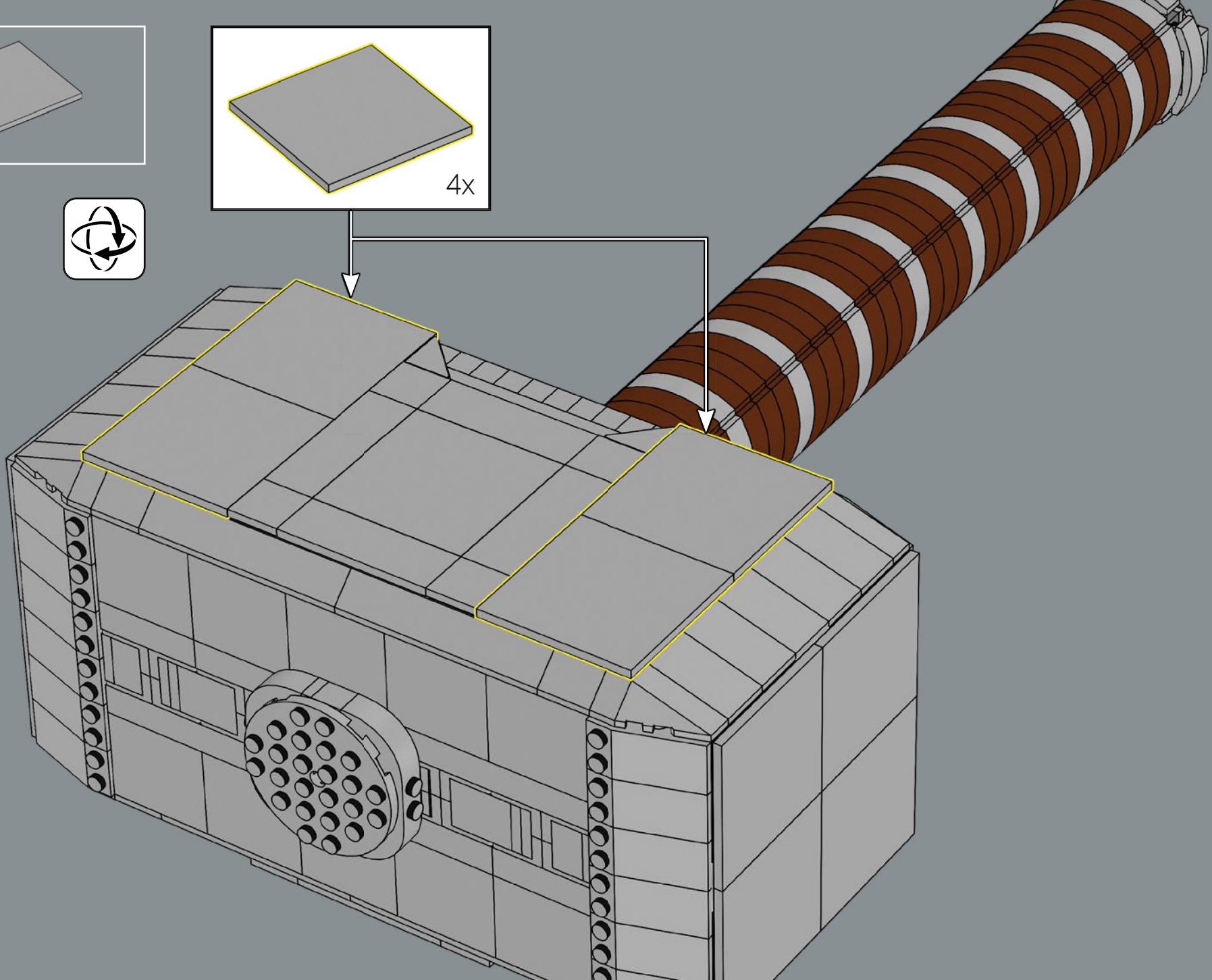
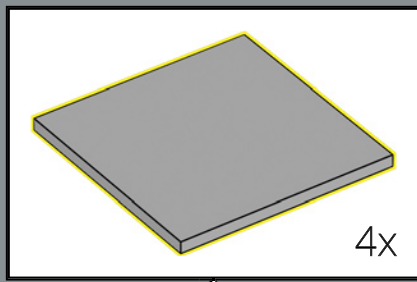

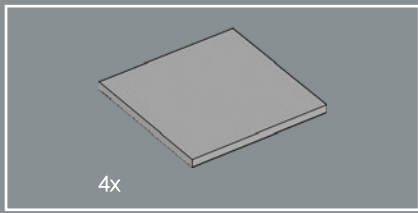

121

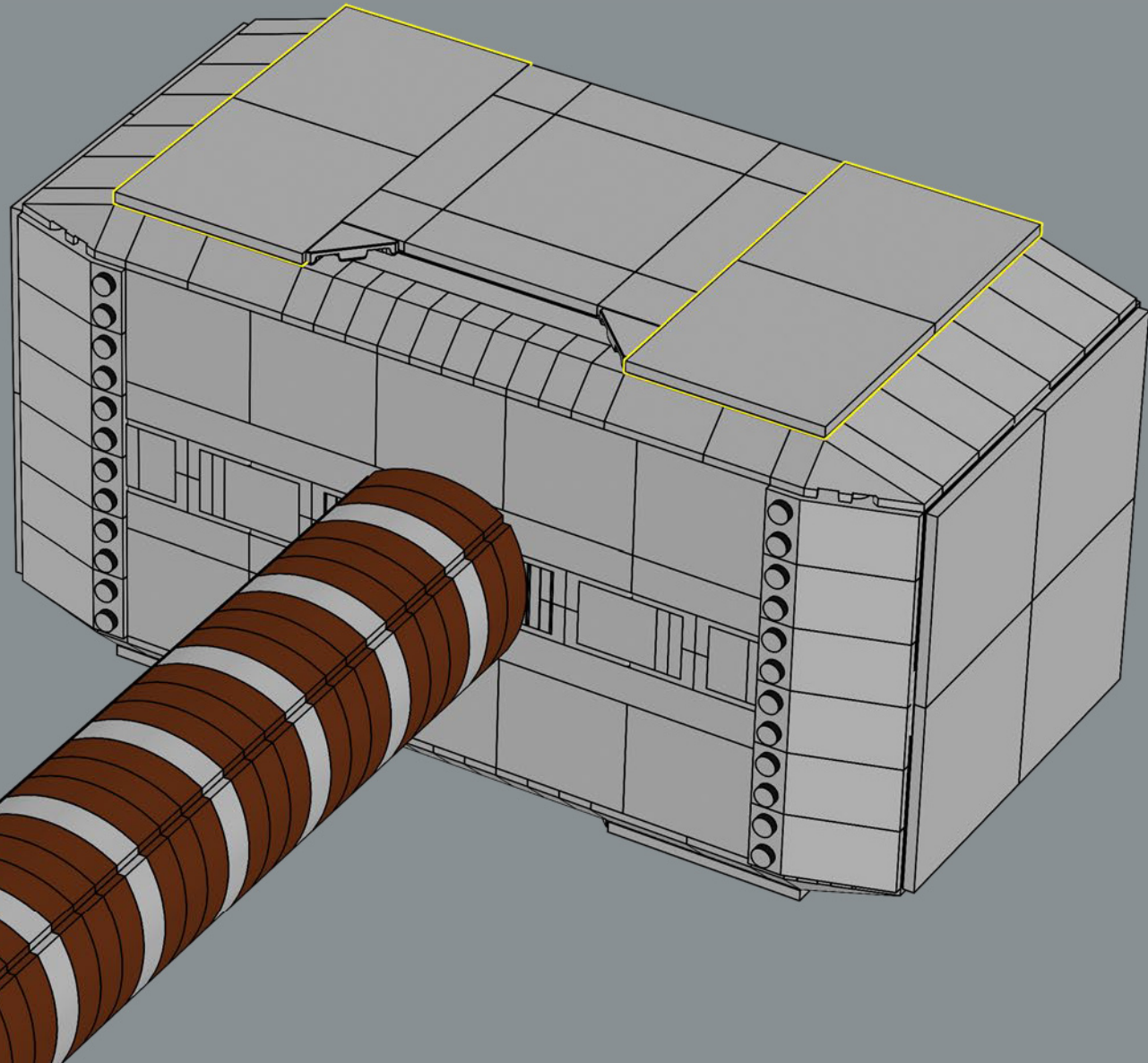

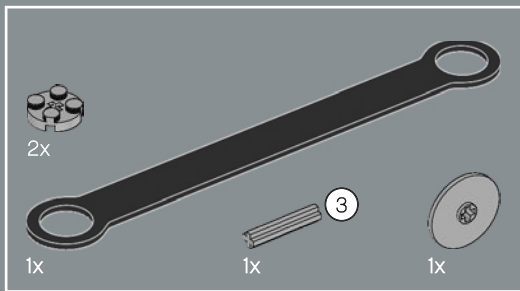

122

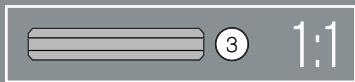
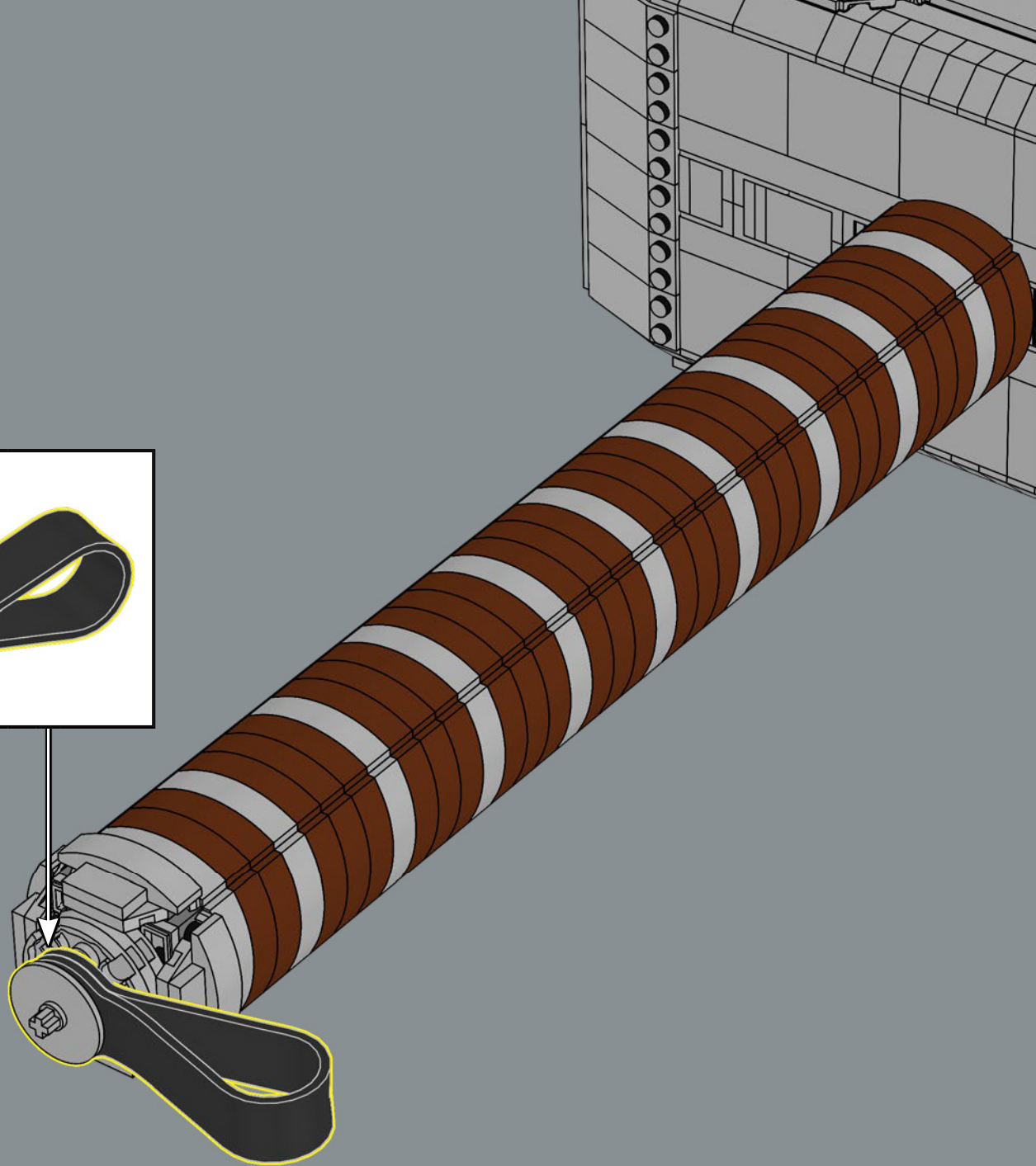
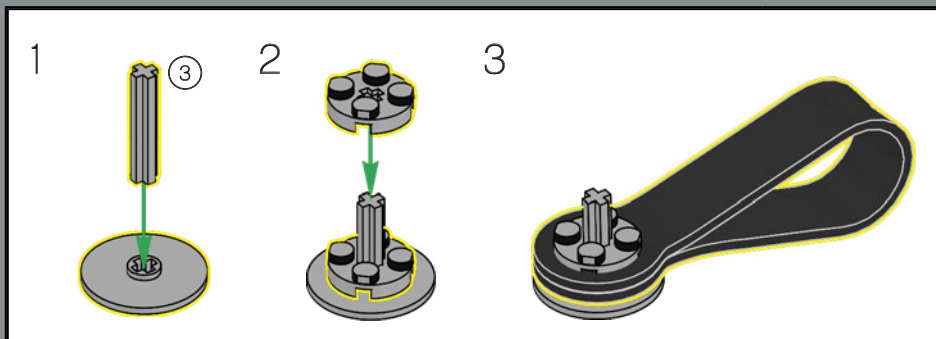

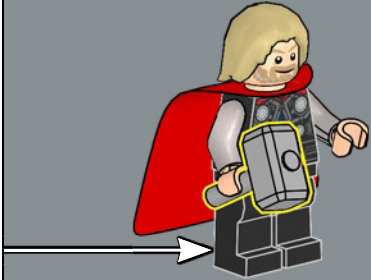
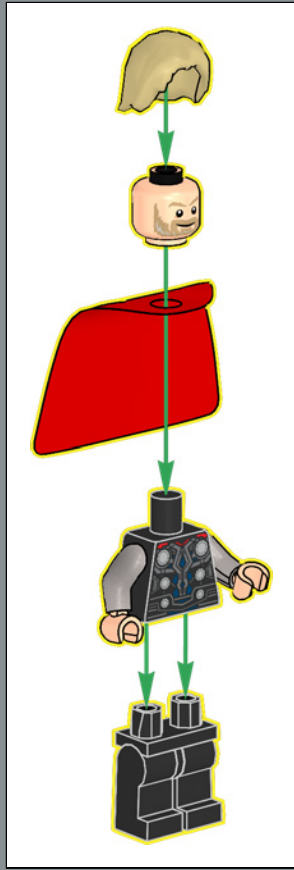
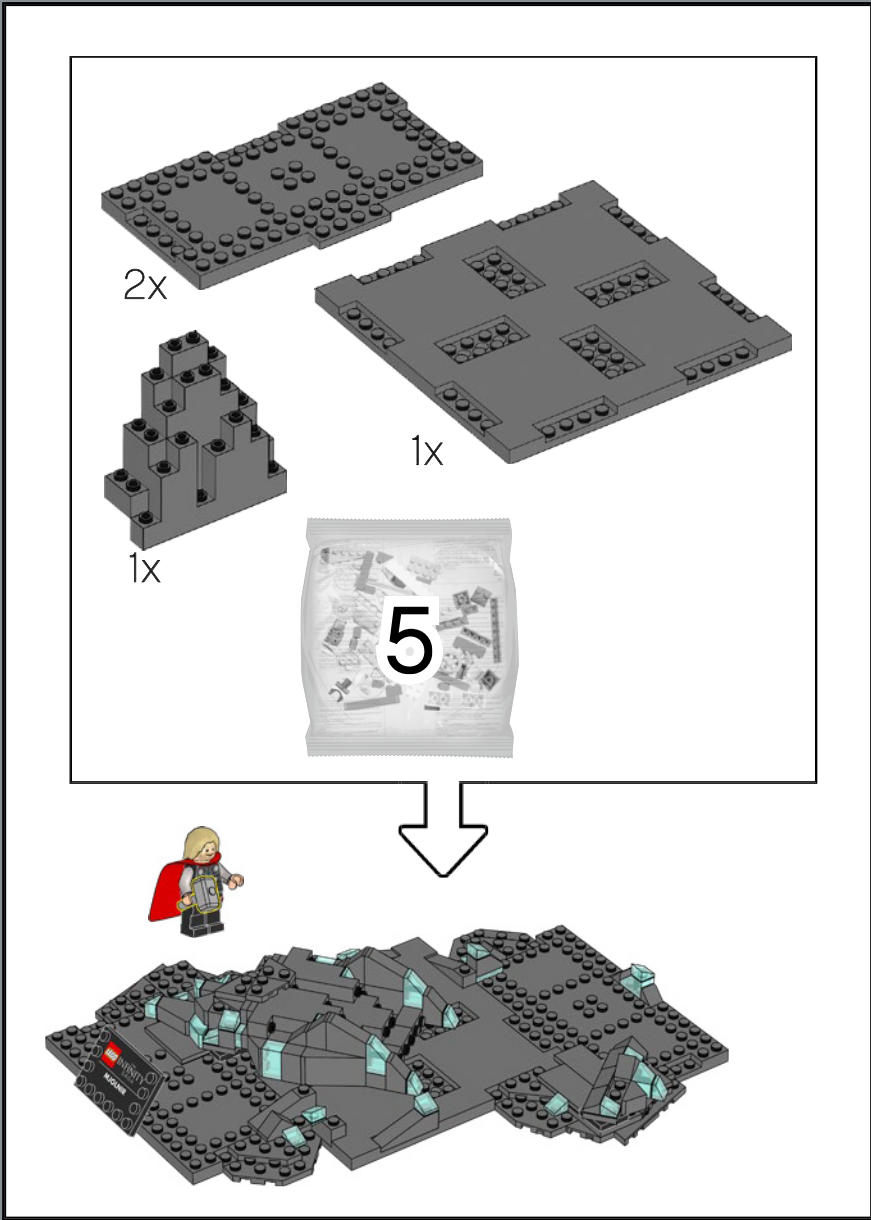

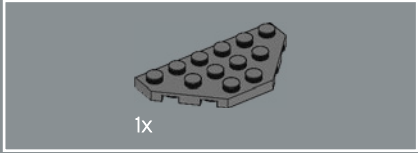
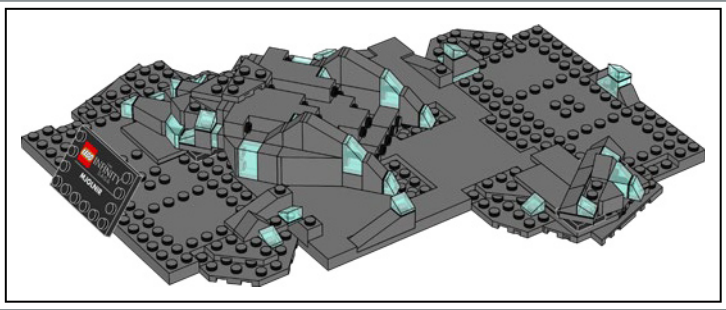

123

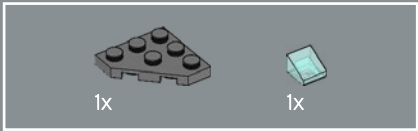
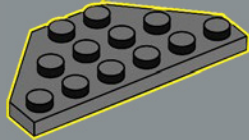

124

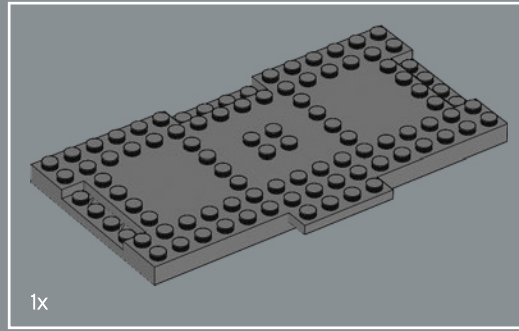
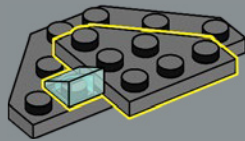

125

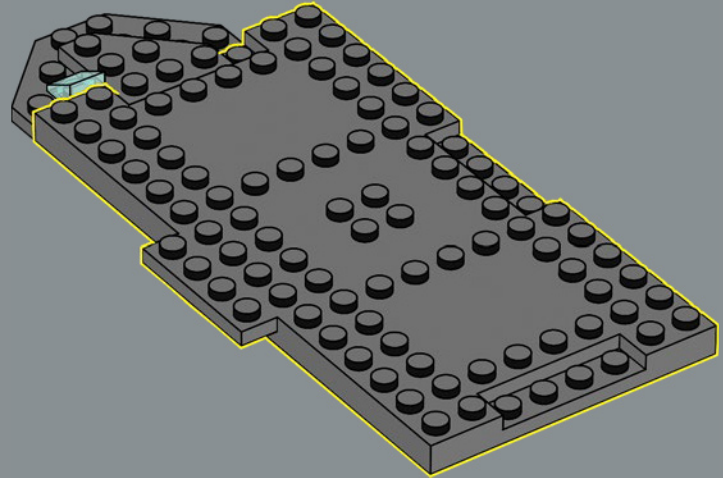



126

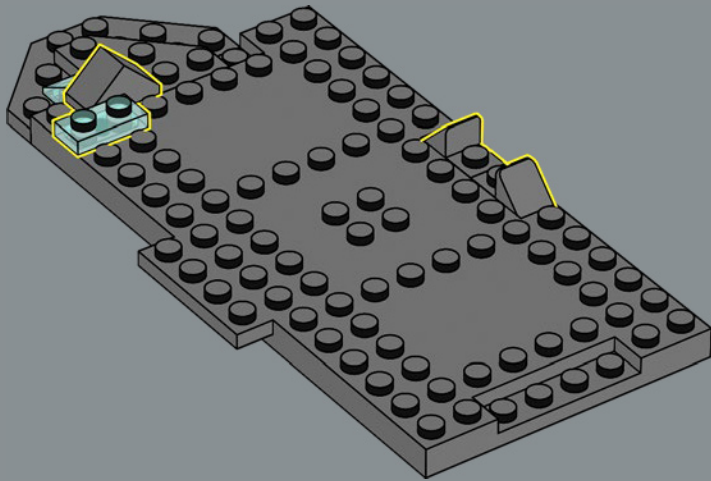

127

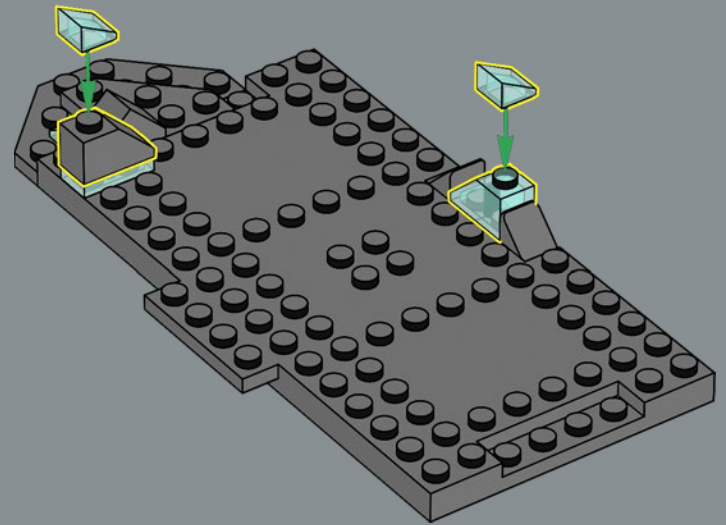

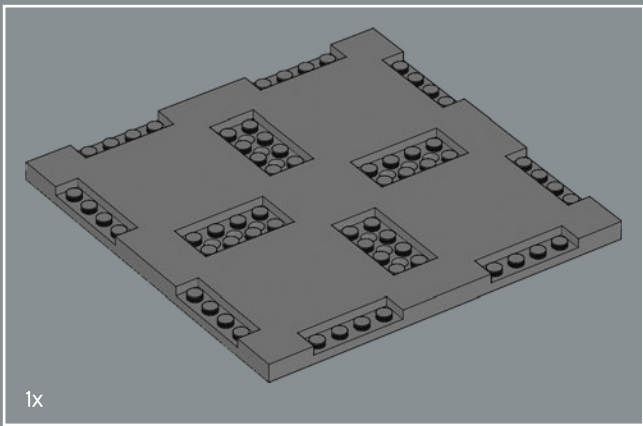

128

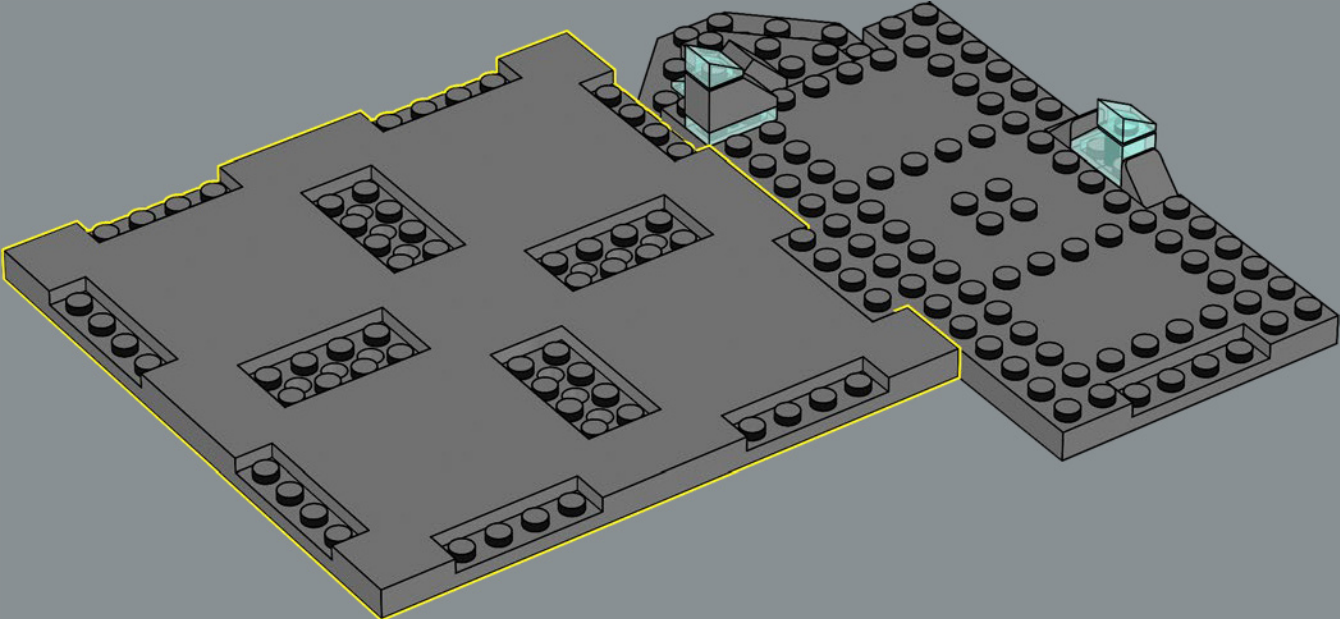

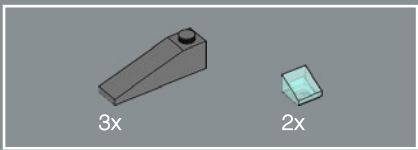

129

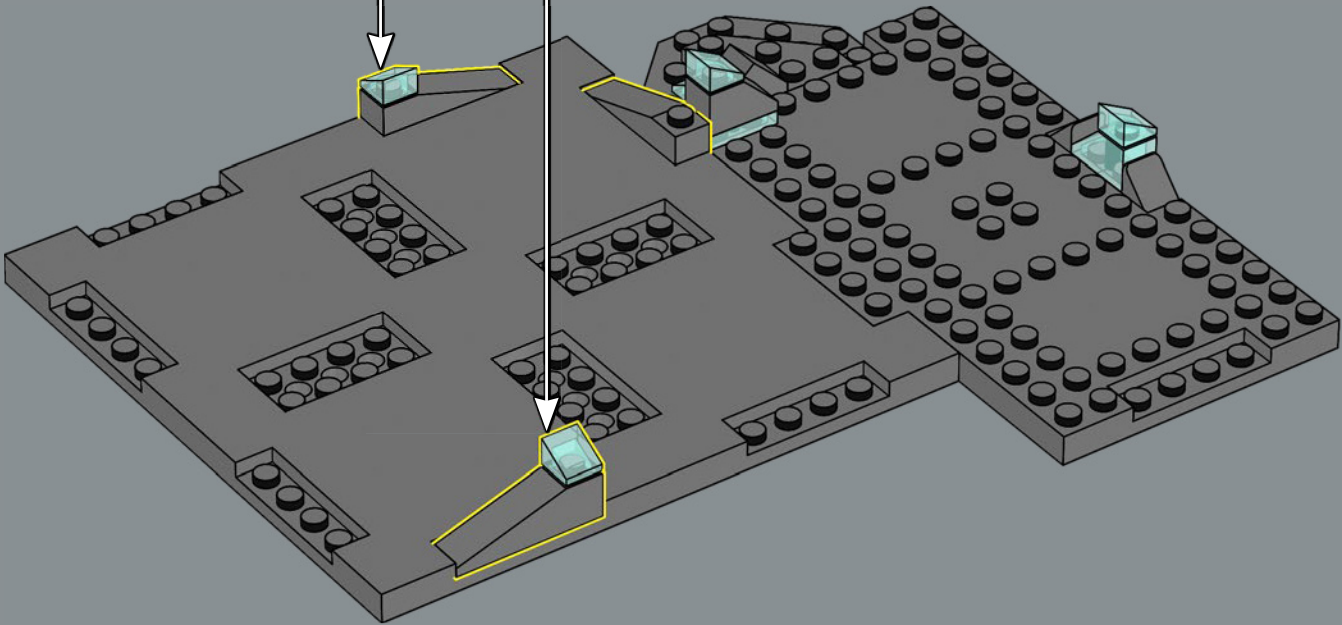
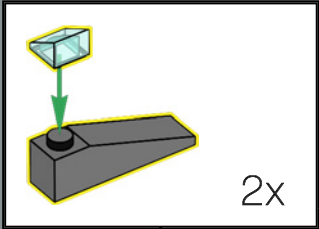

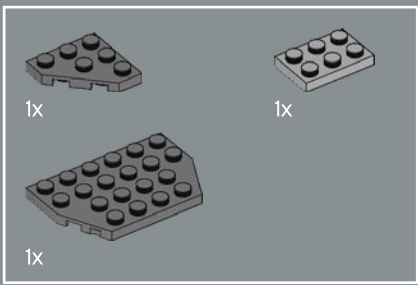

130

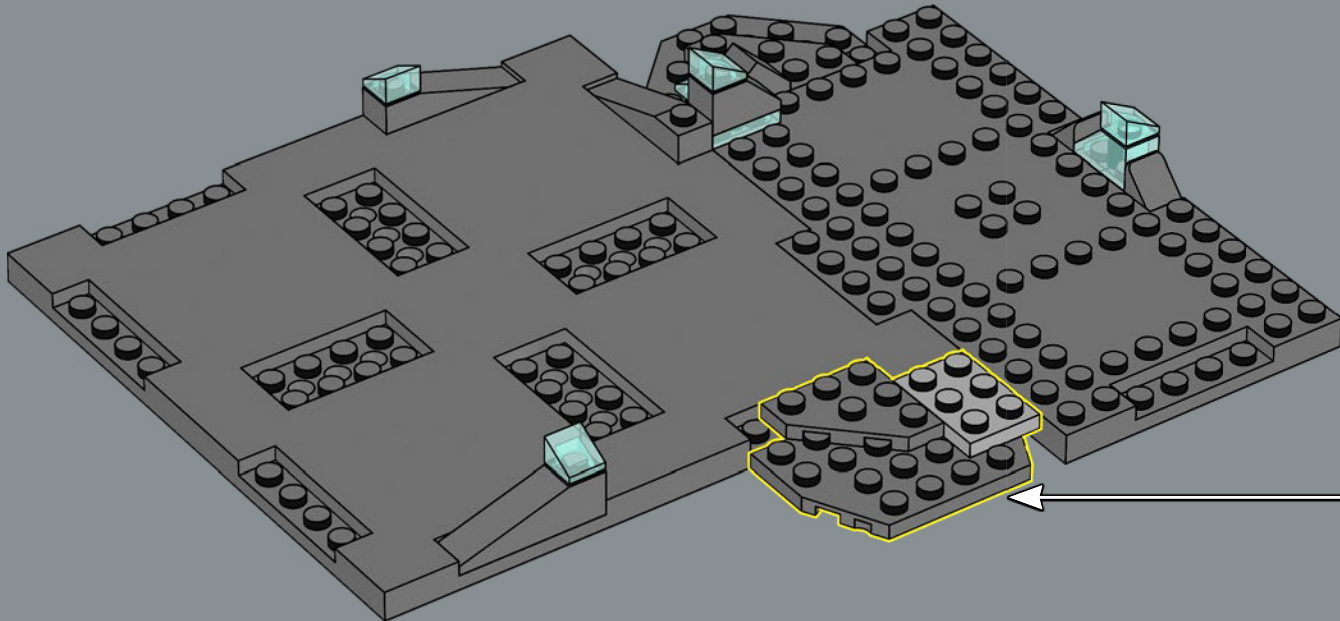
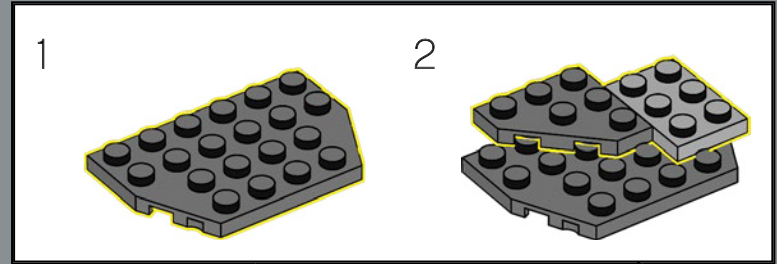

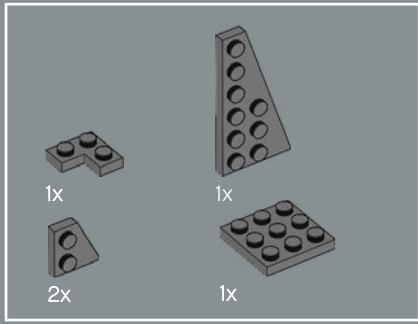

131

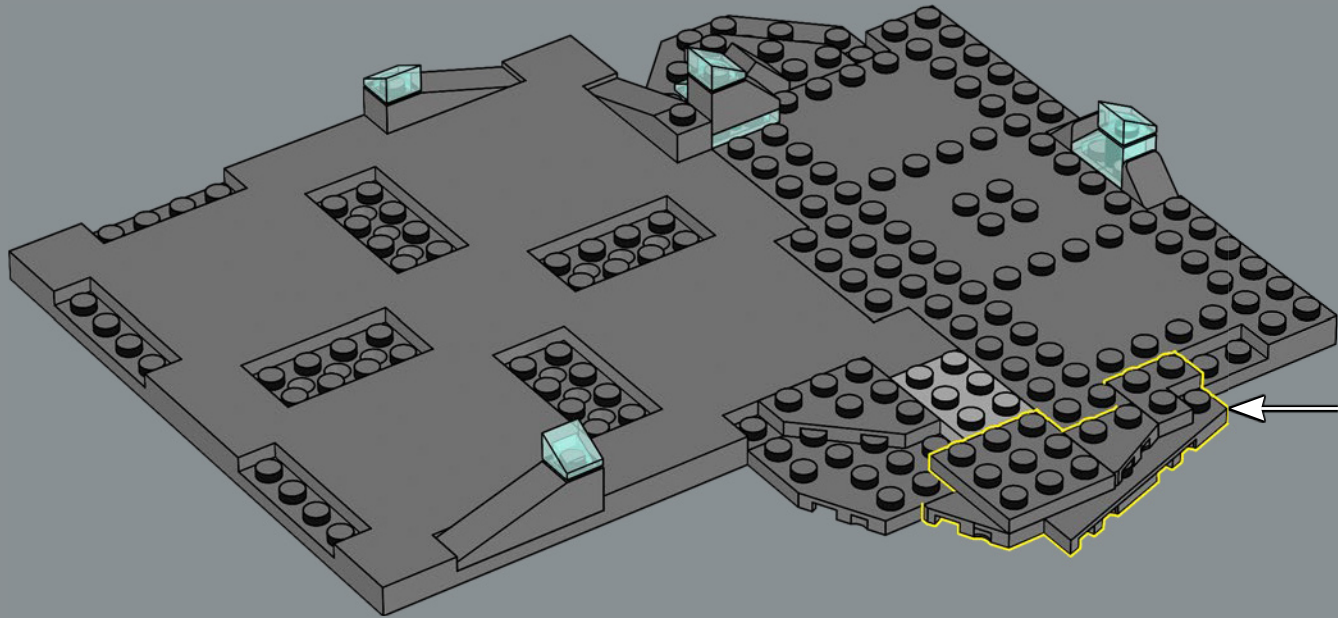
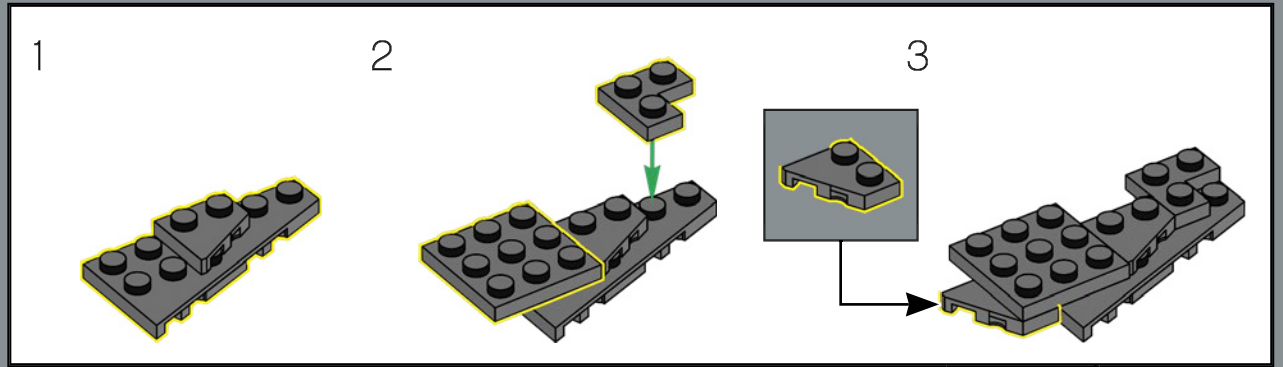

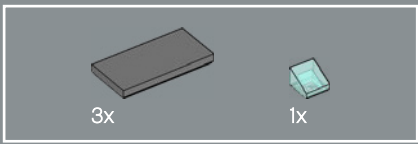

132

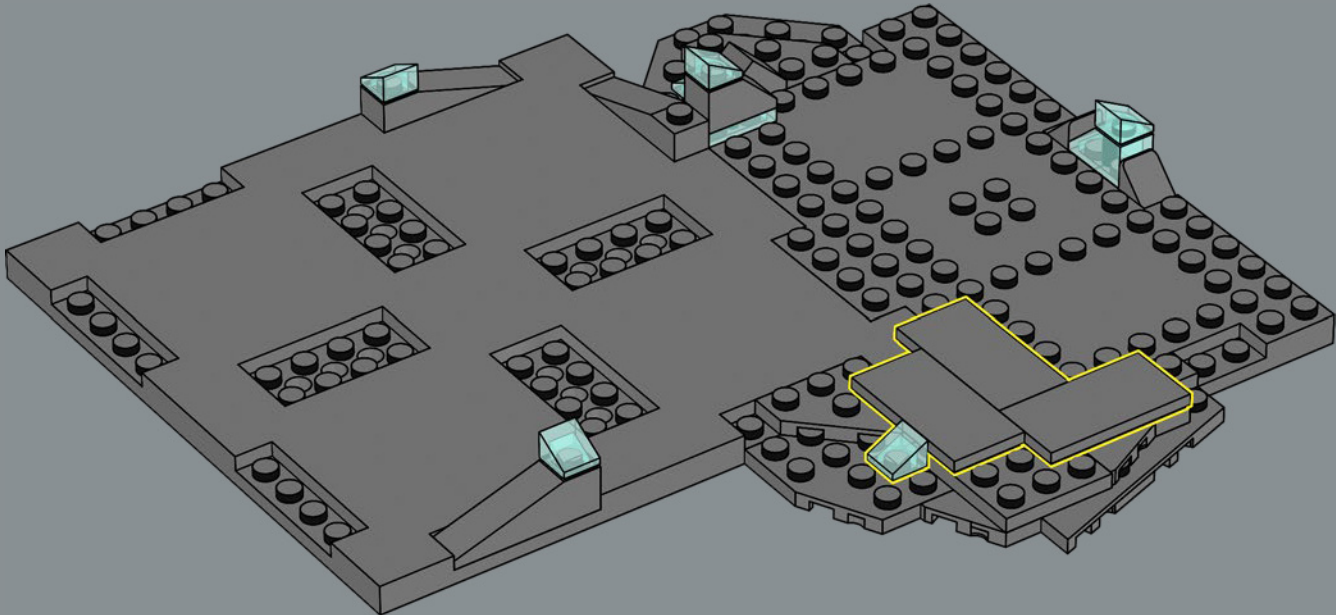



133

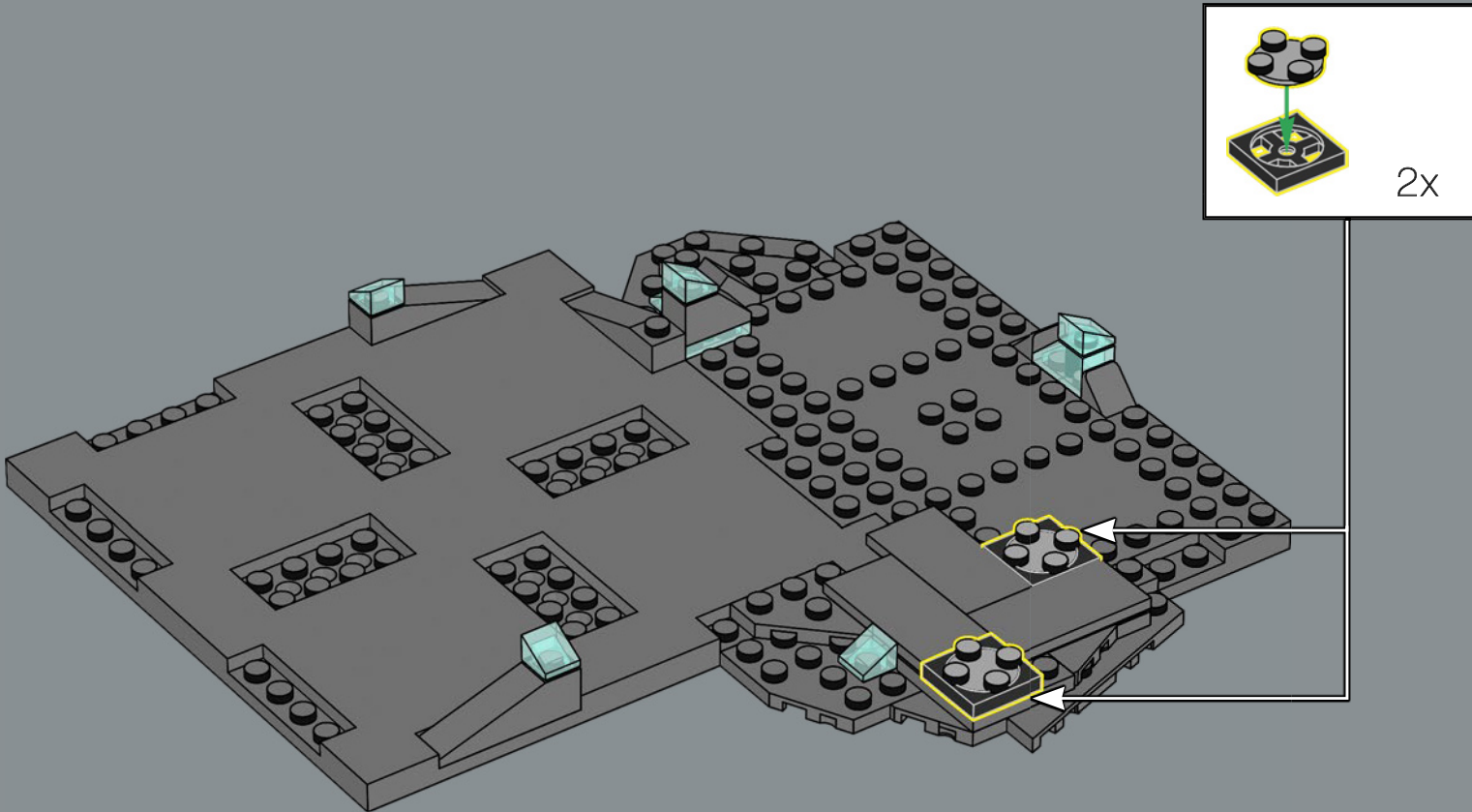



1x

134

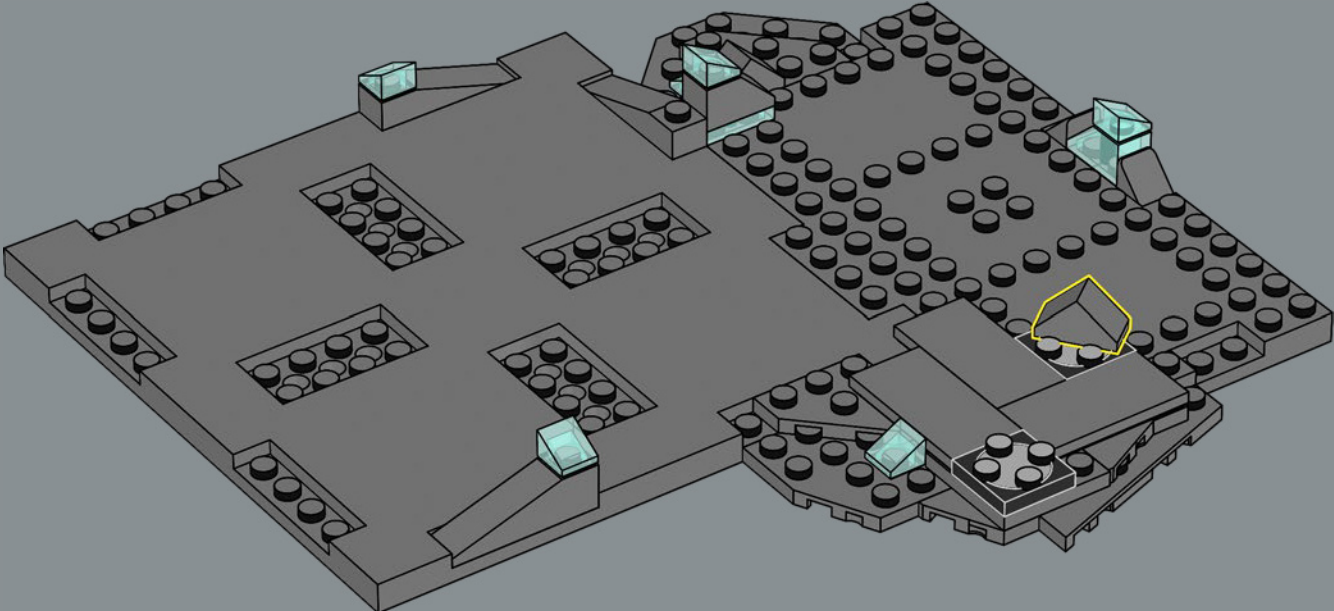

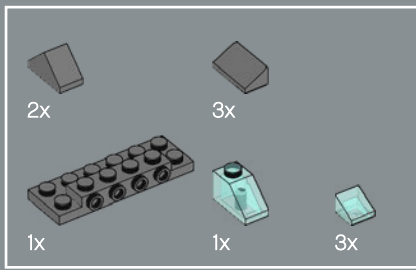

135

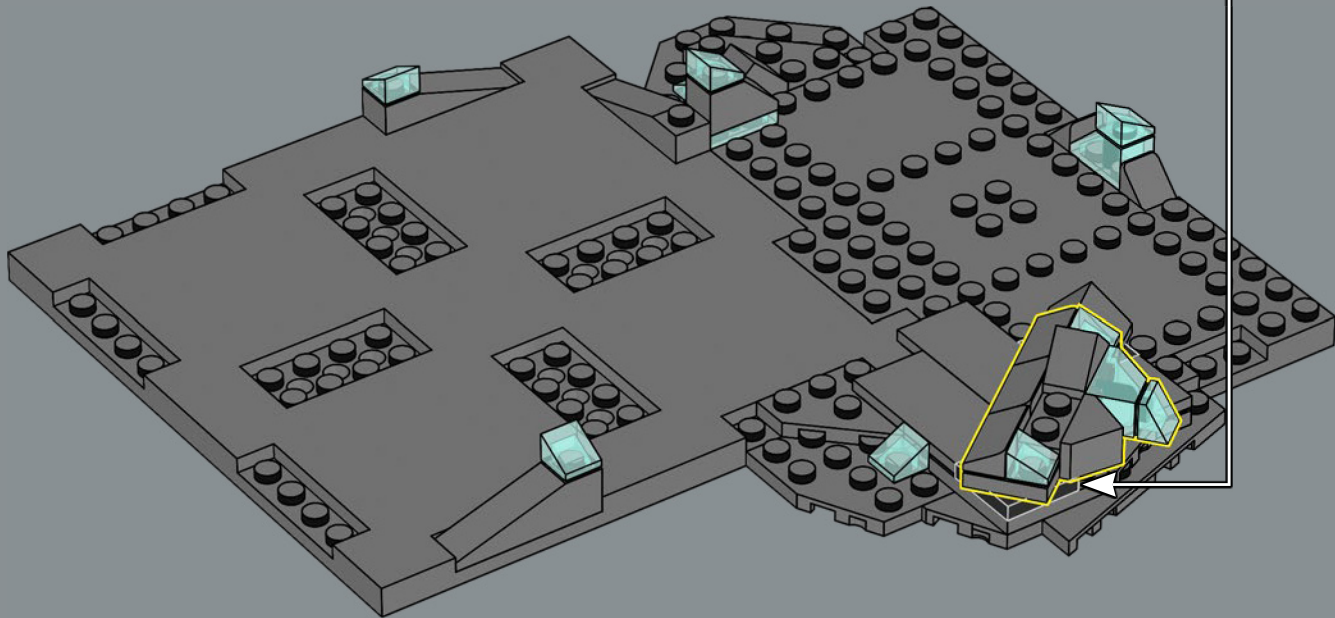
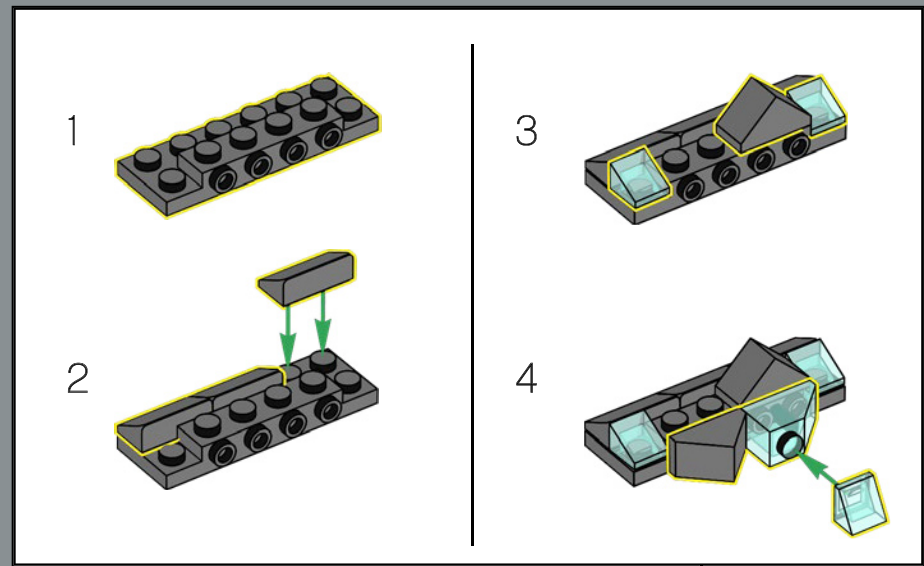

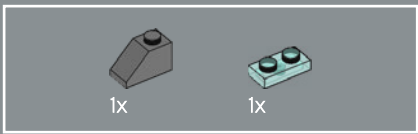

136

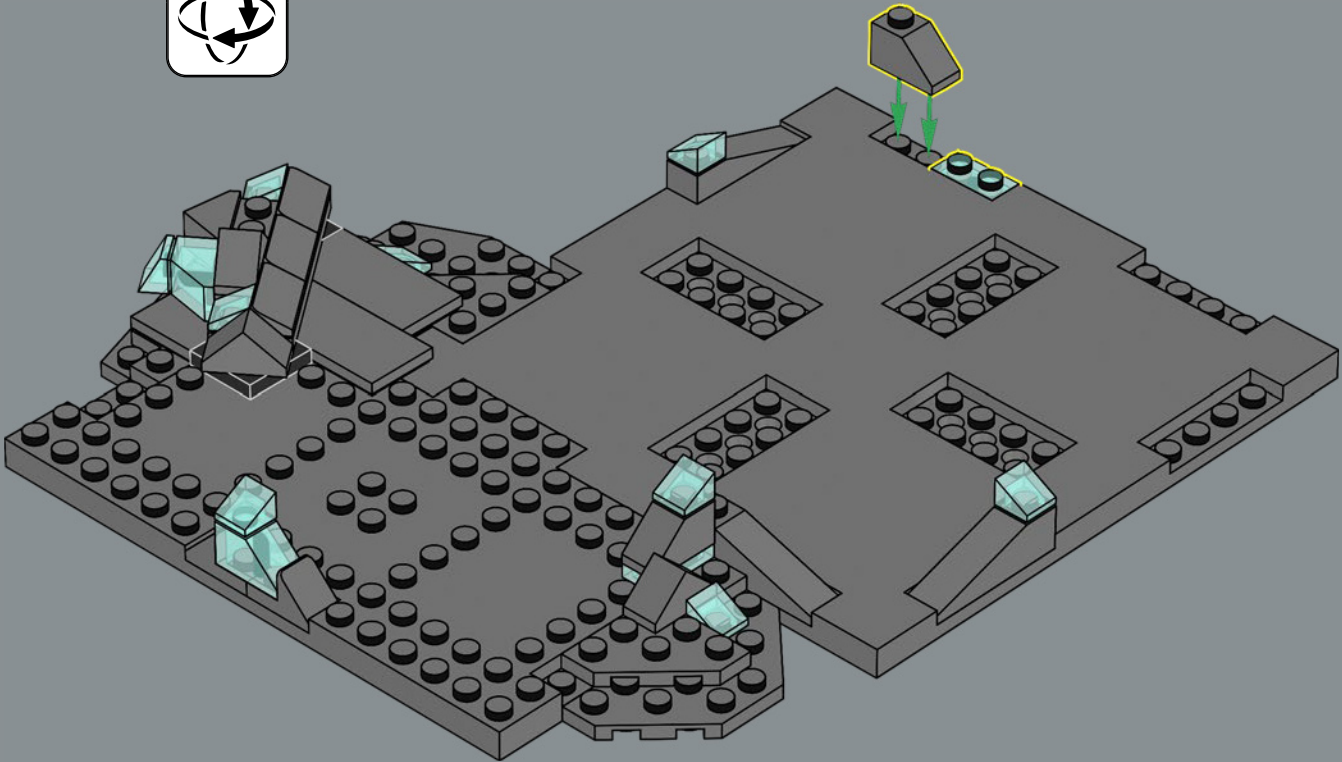

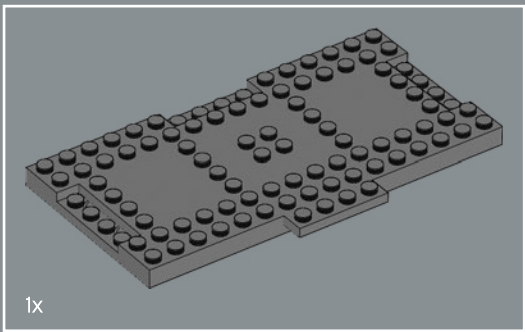

137

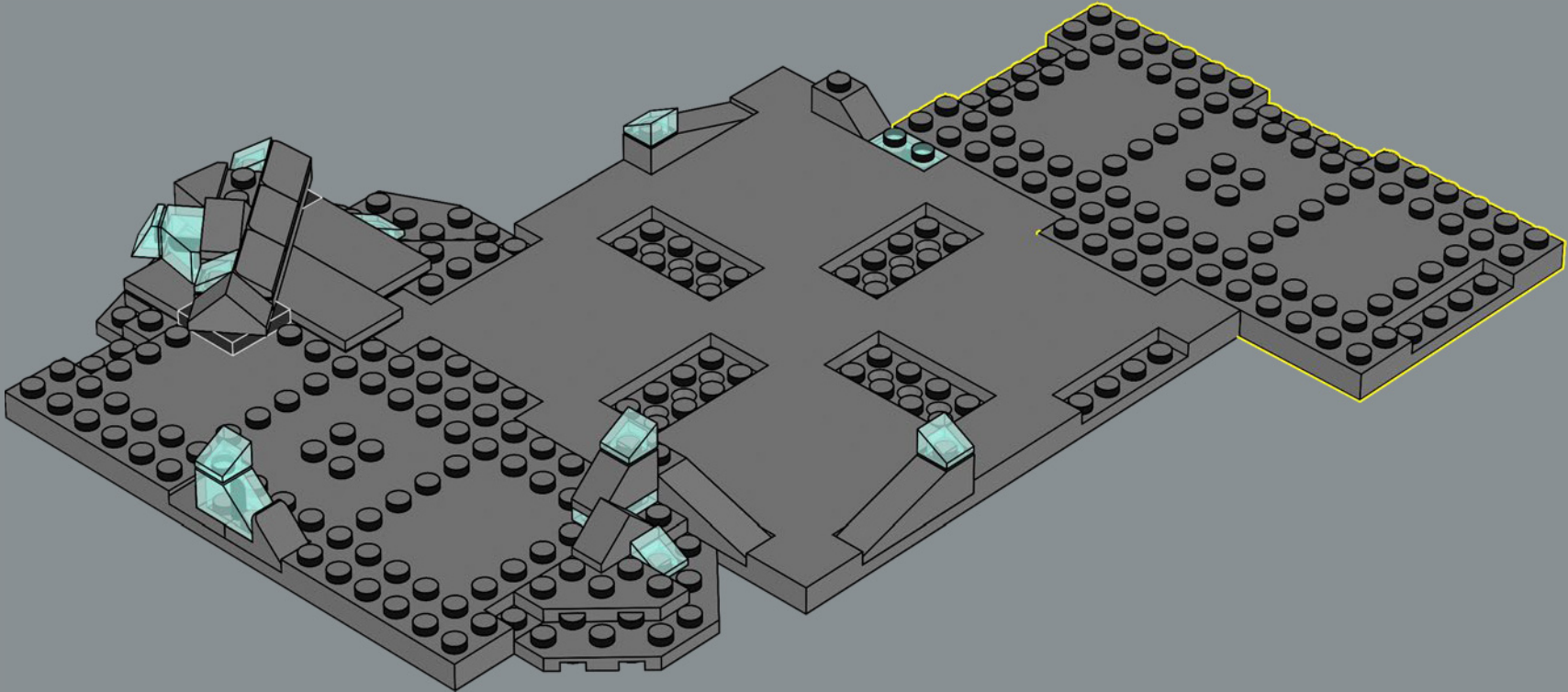

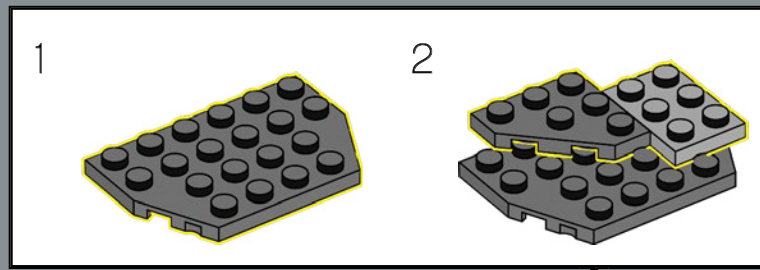
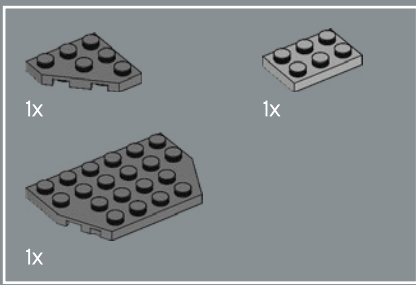

138

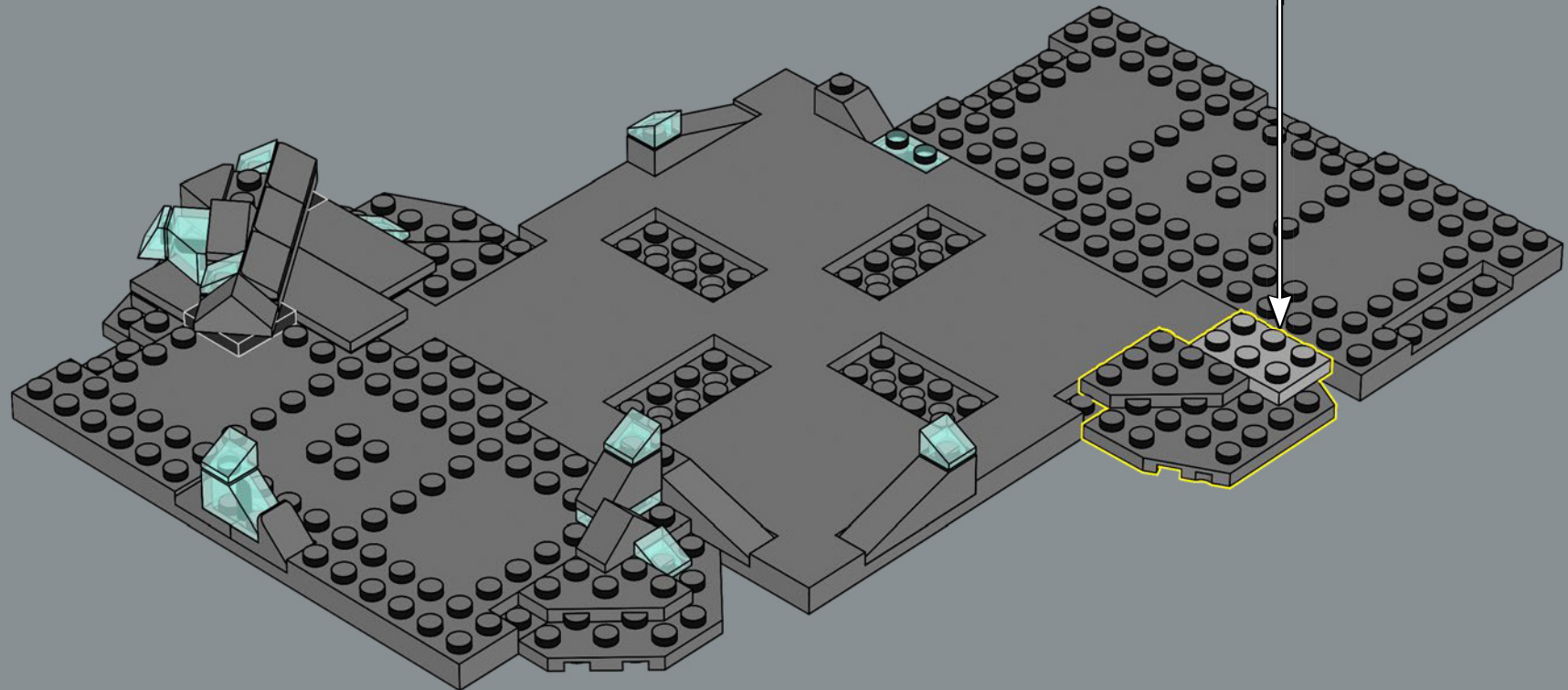

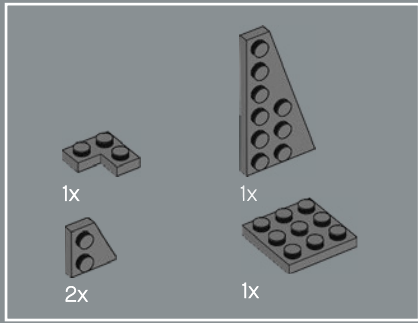

139

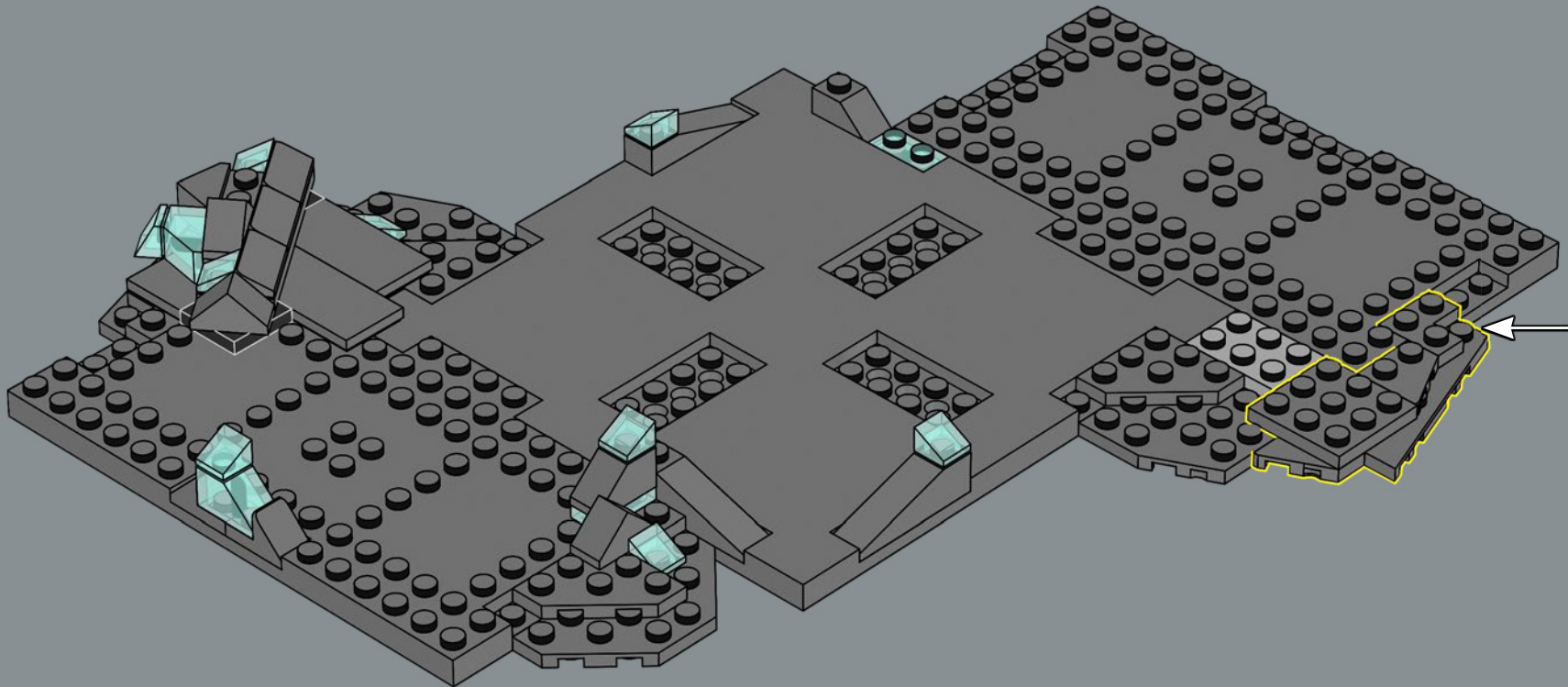
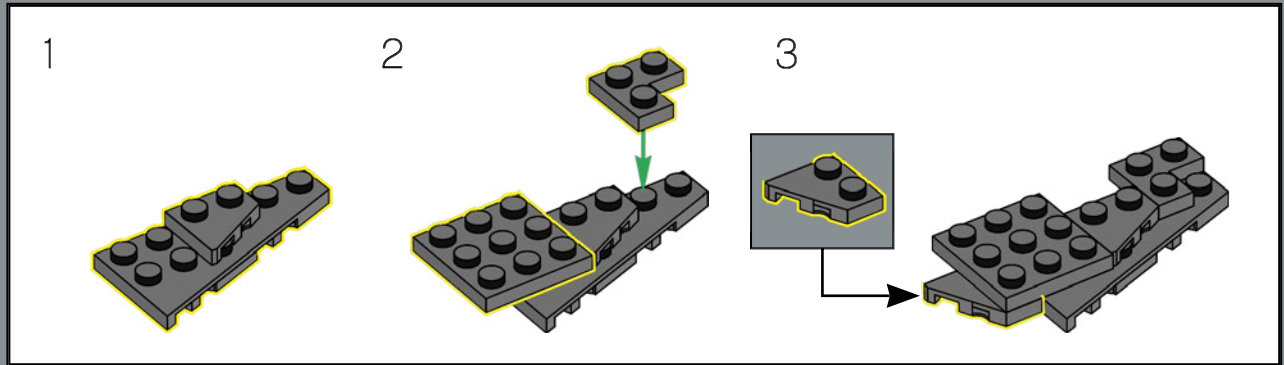

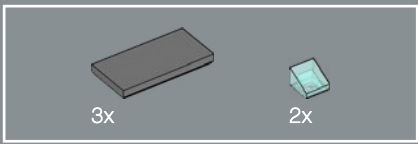

140

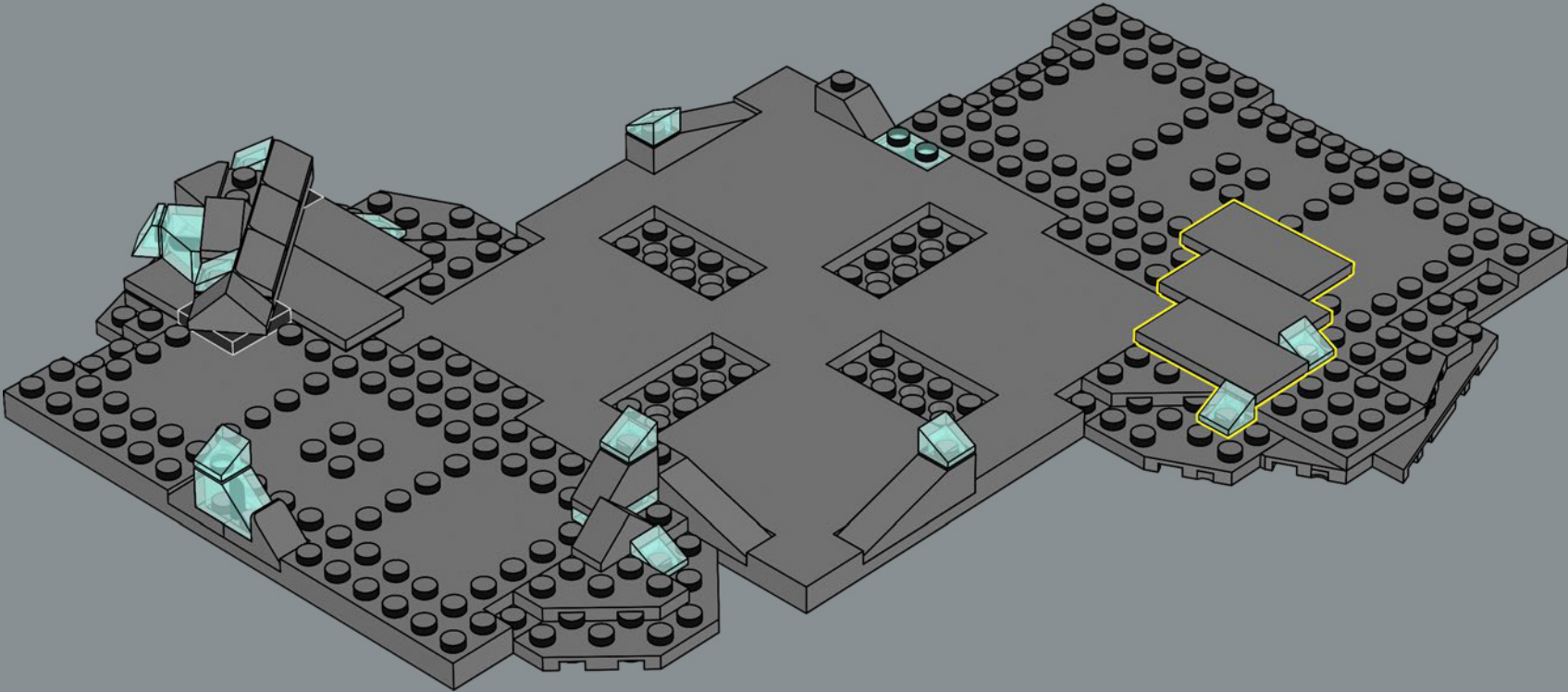



141

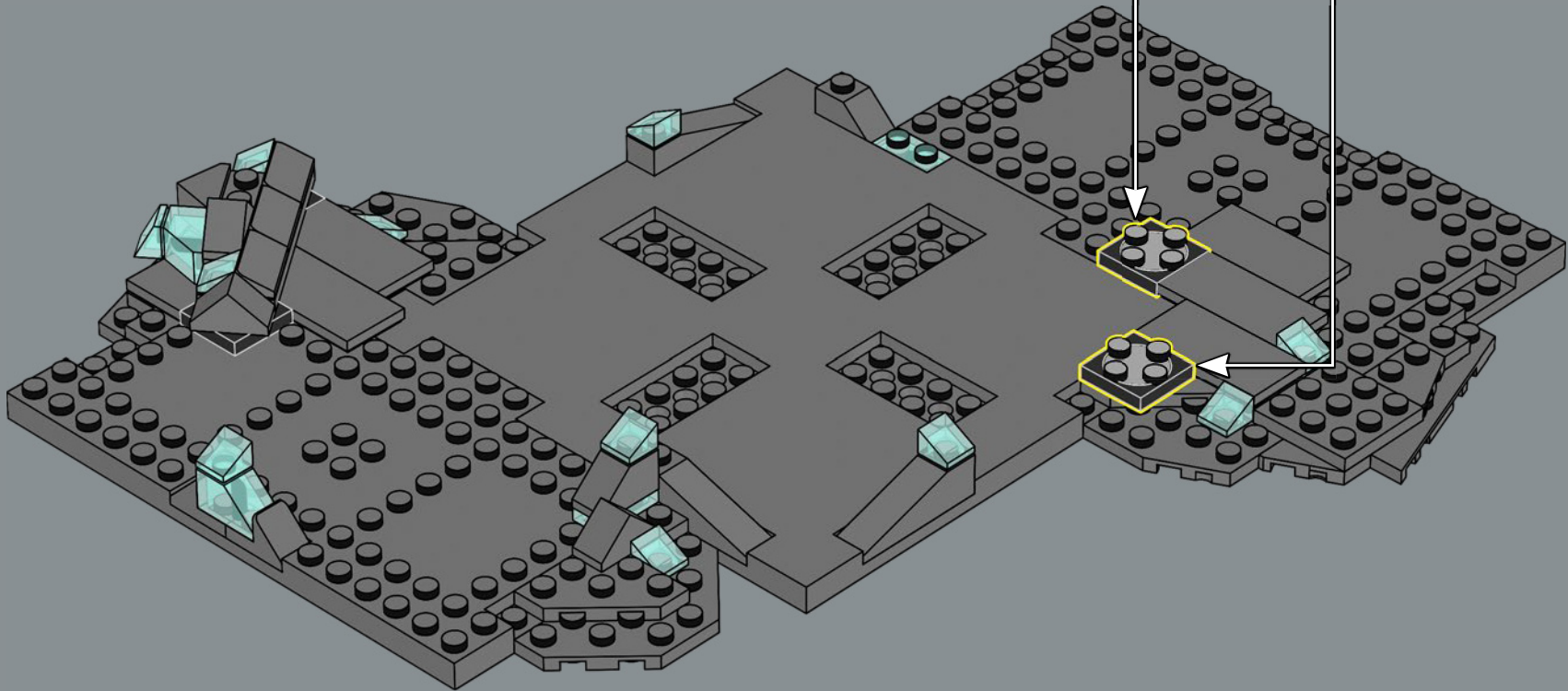
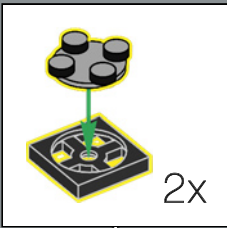

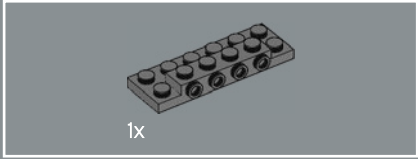
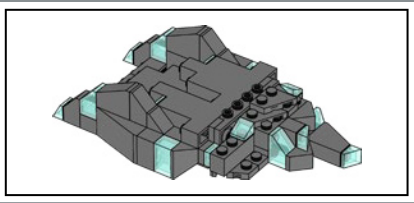

142

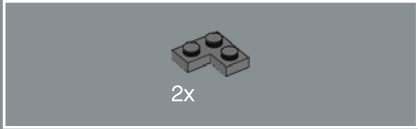
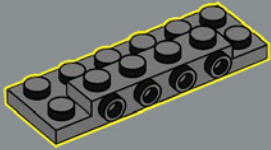

143

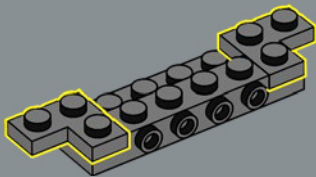

144

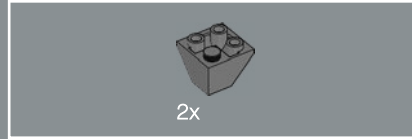
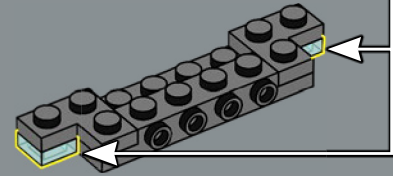

145

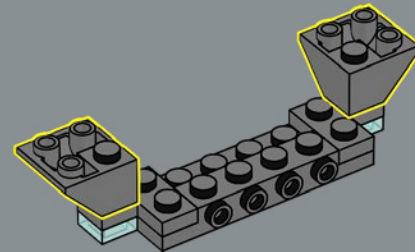

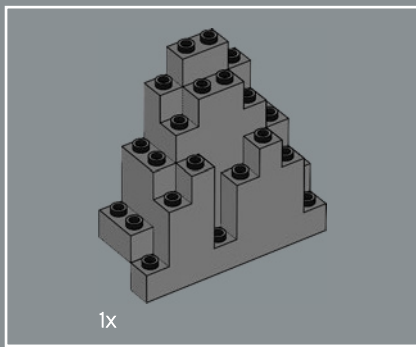

146

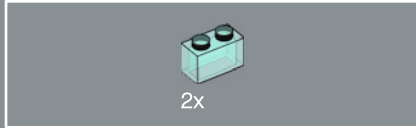
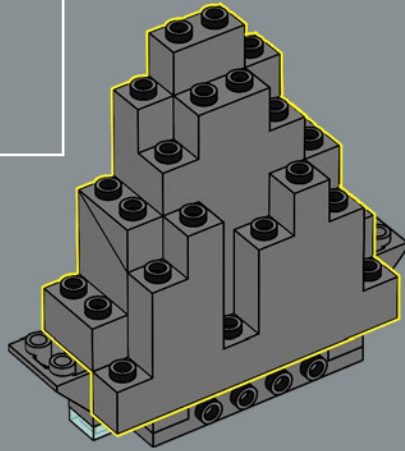

147

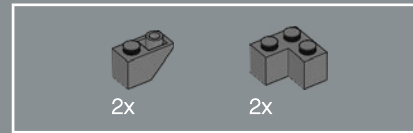
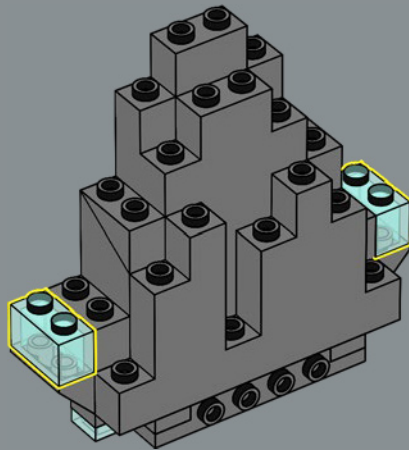

148

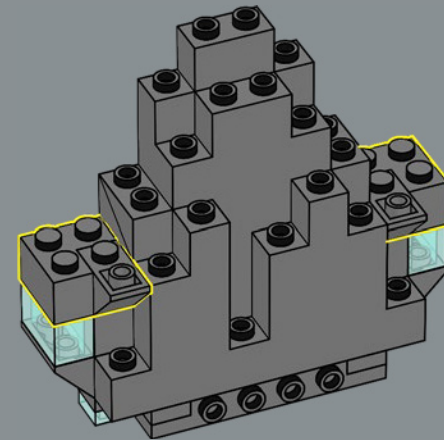



2x

149

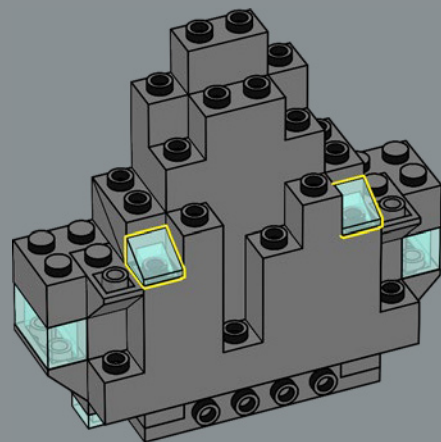

2x

150

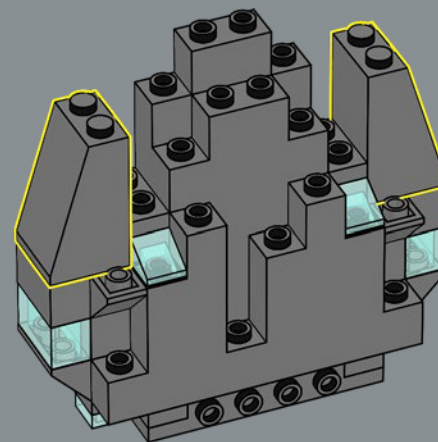

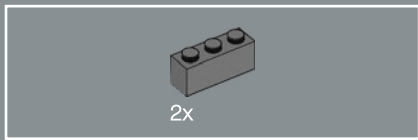

151

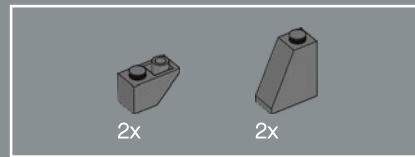
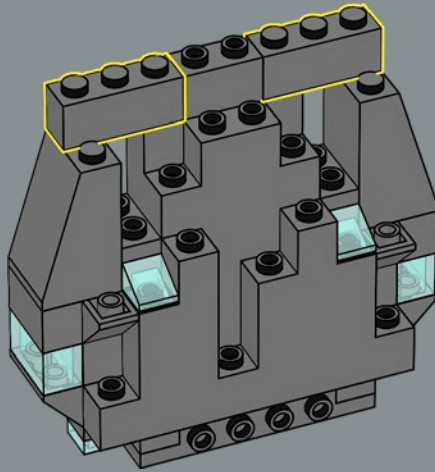

152

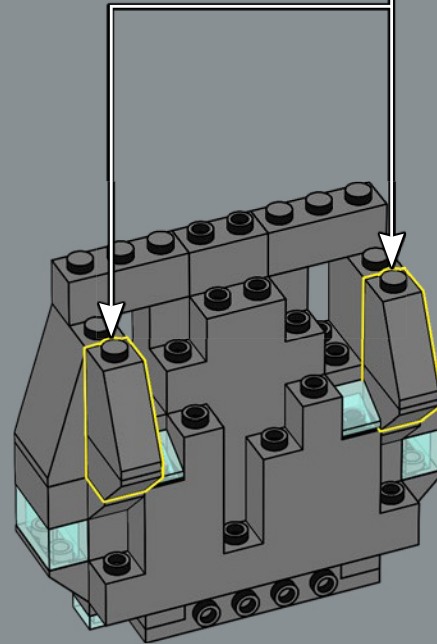
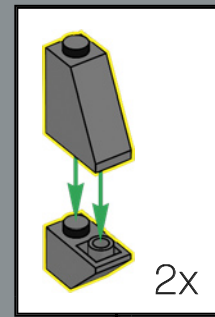



2x

153

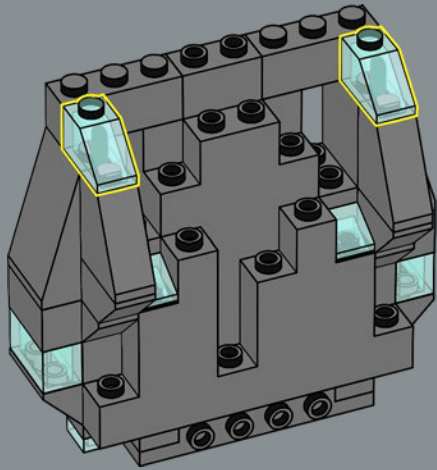

2x



2x

154

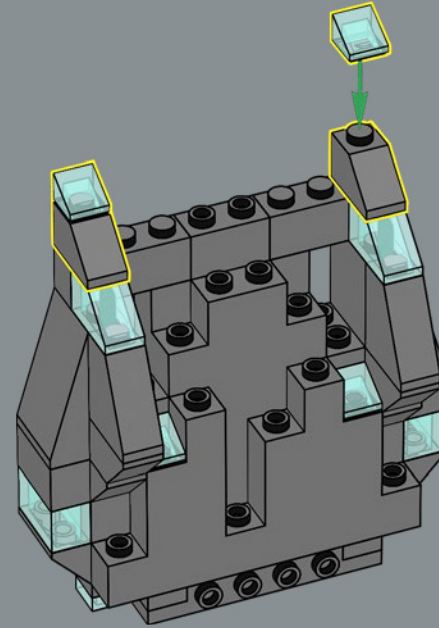

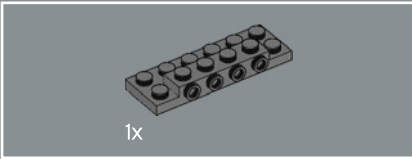
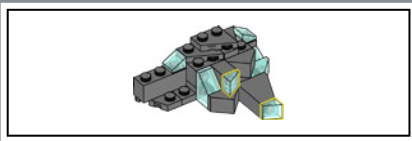

155

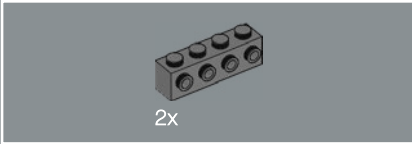
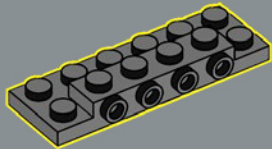

156

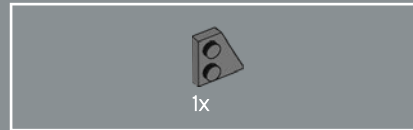
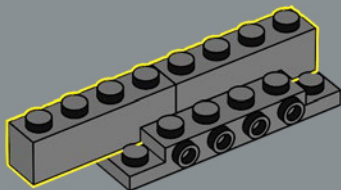

157

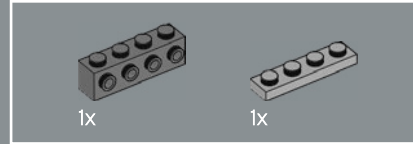
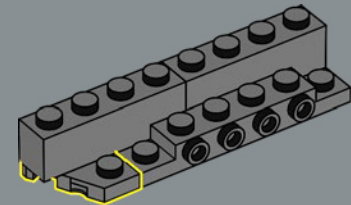

158

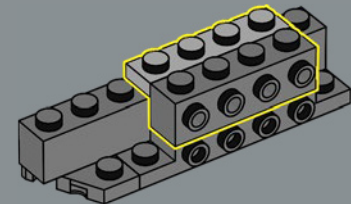

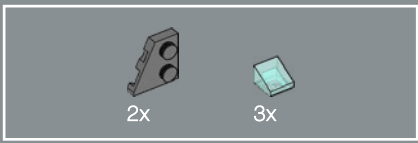

159

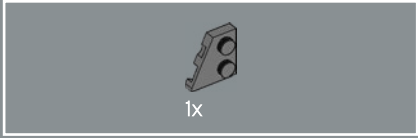
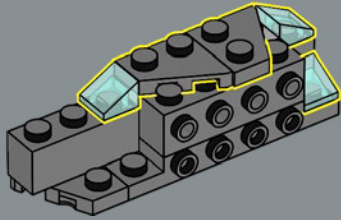

160

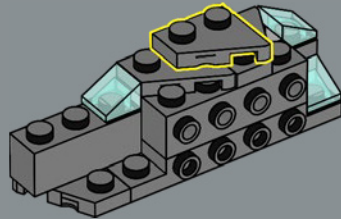

161

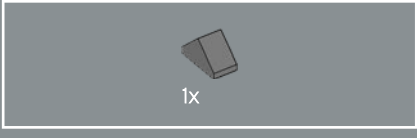
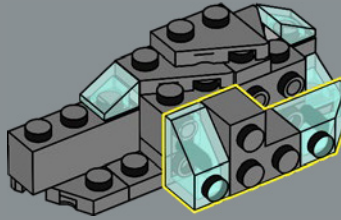

162

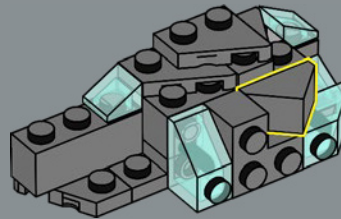

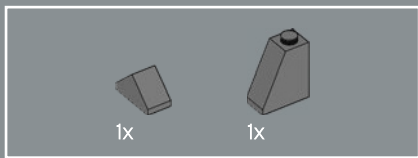

163

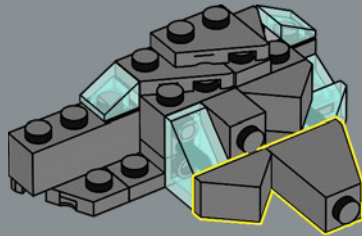

164

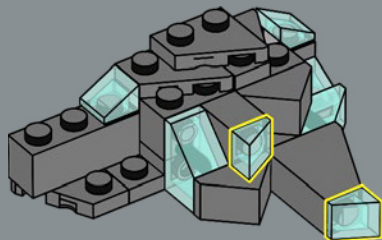

165

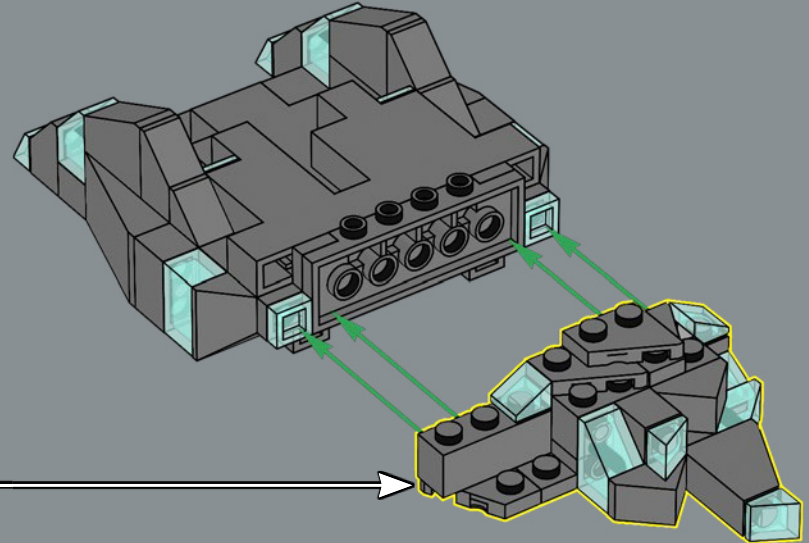

166

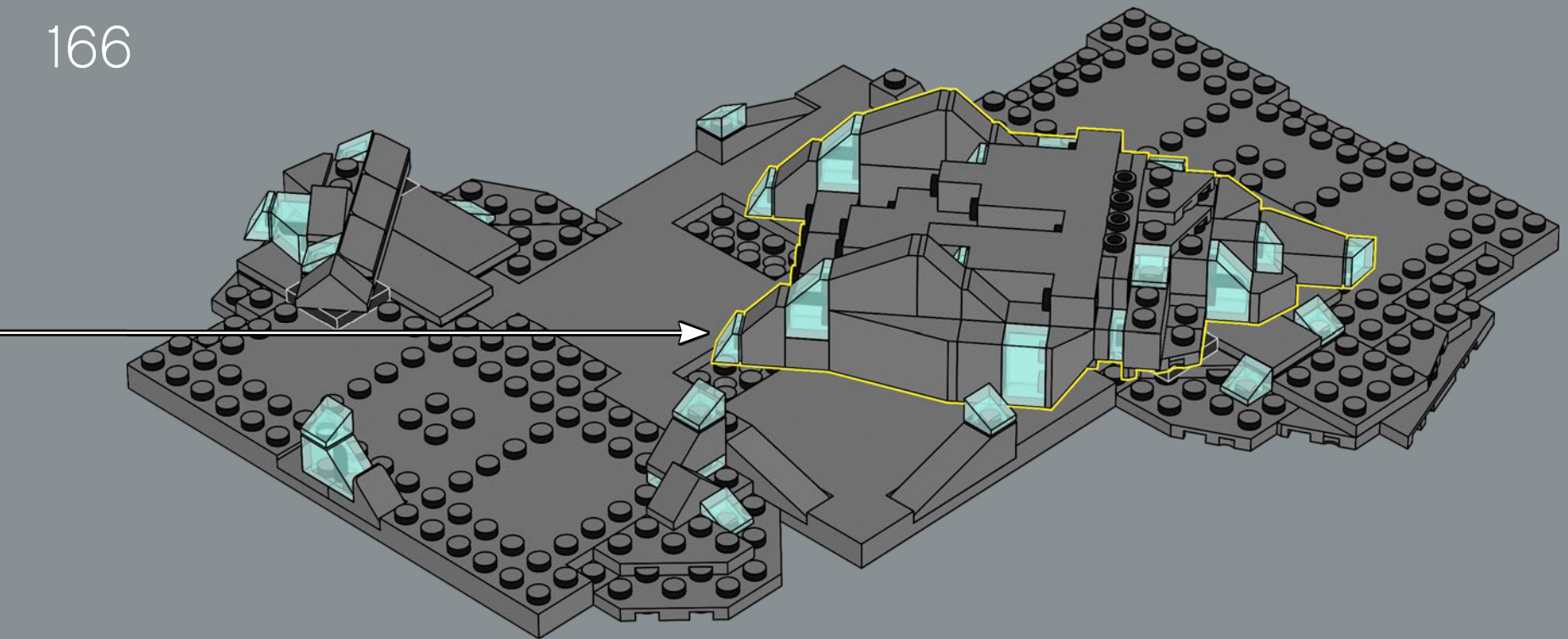

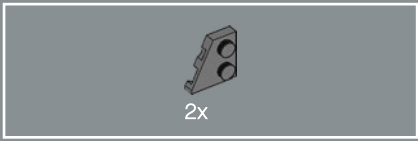

167

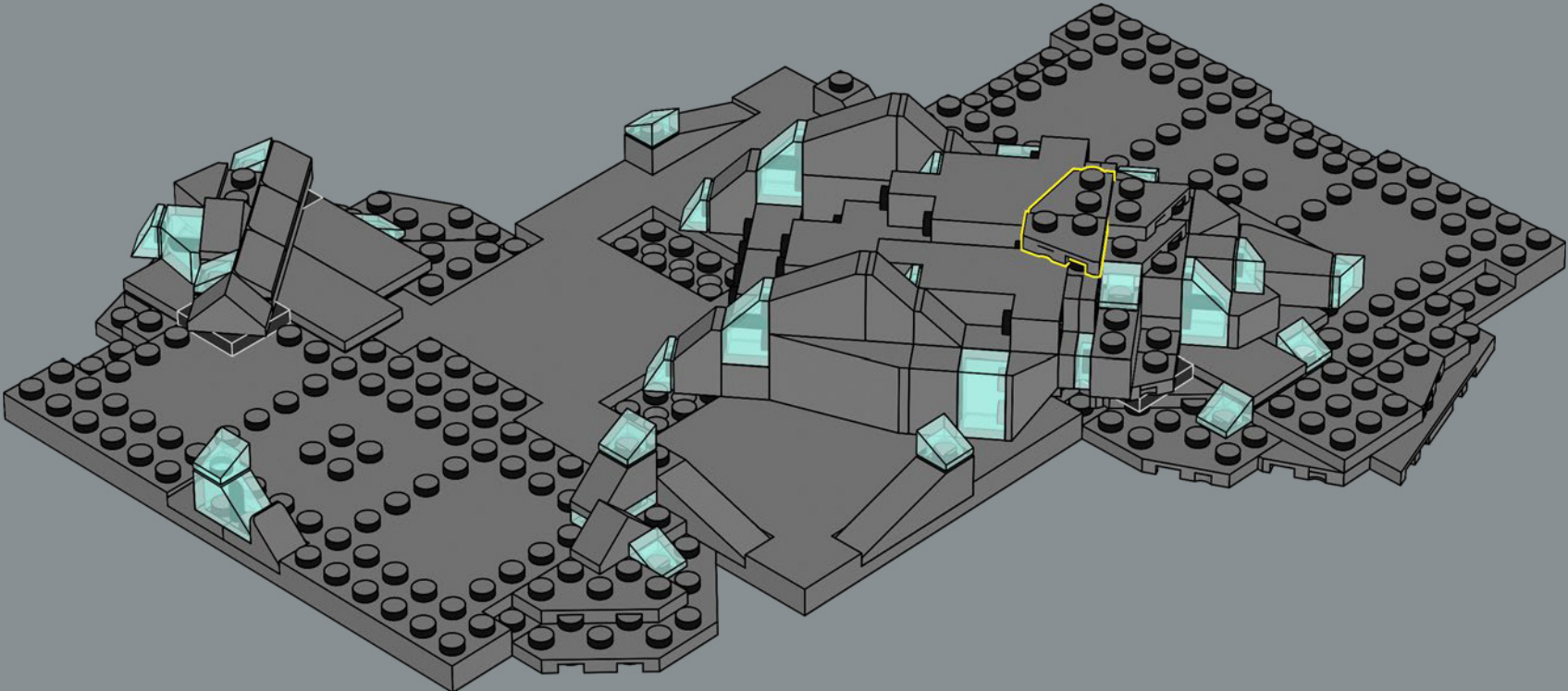

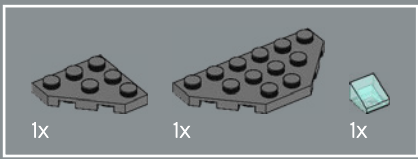

168

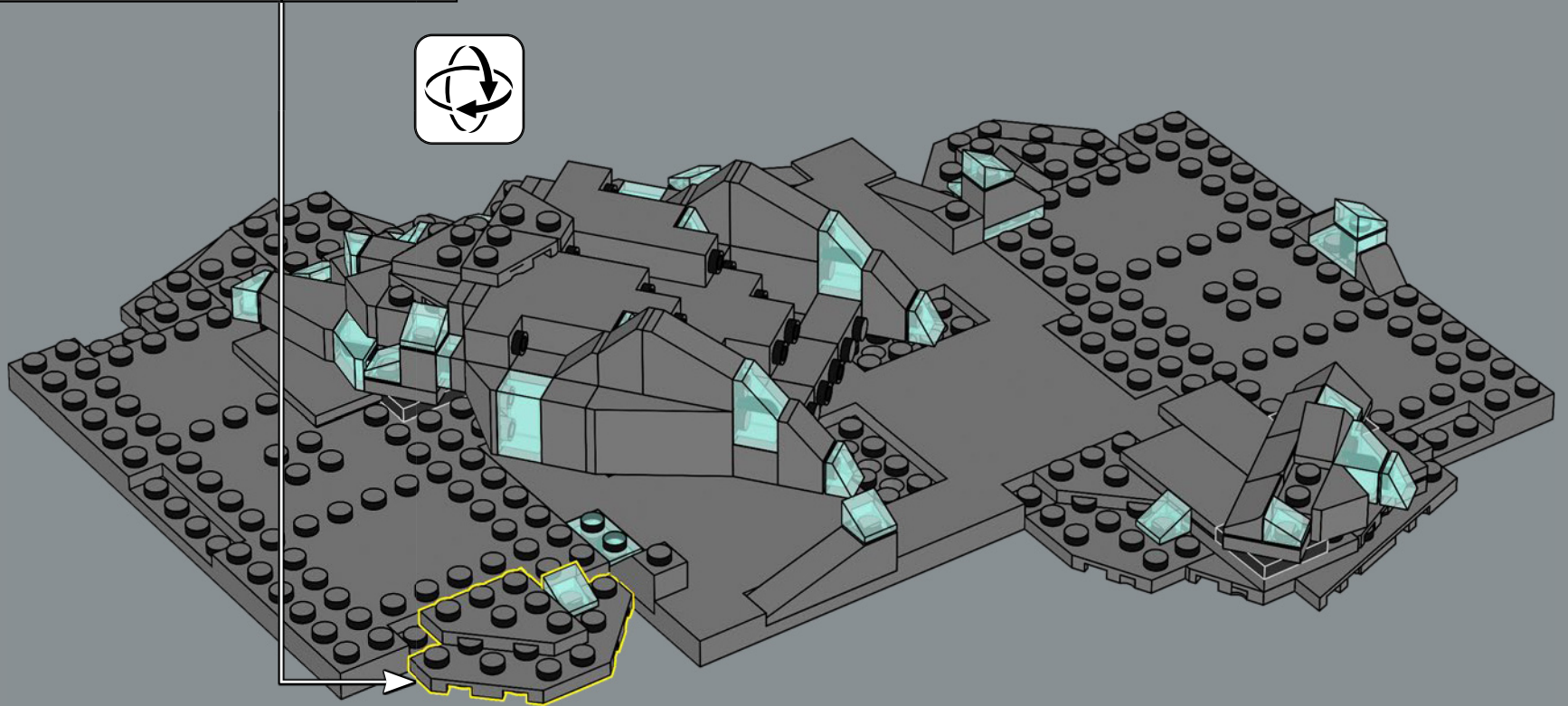
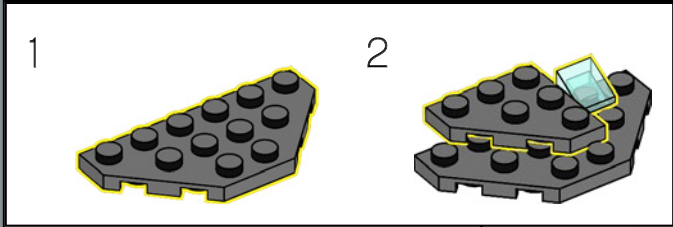

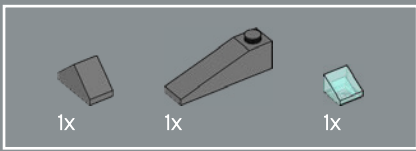

169

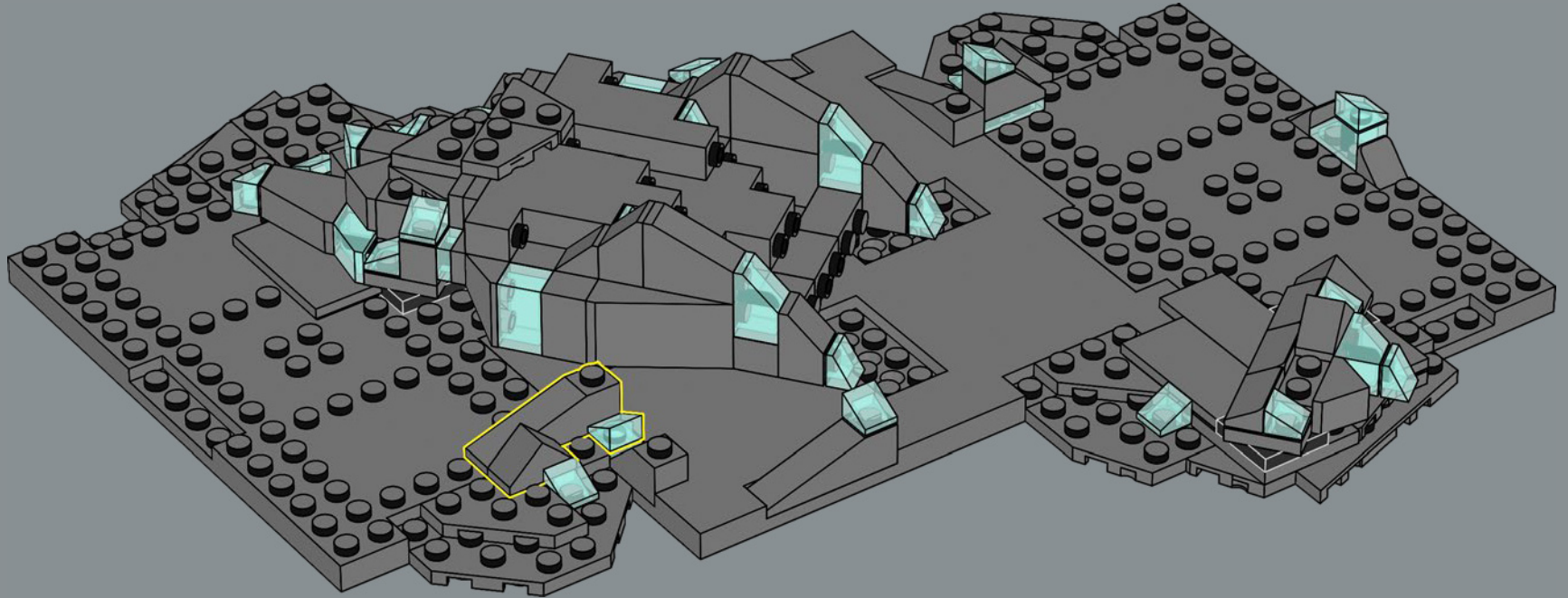



2x

170

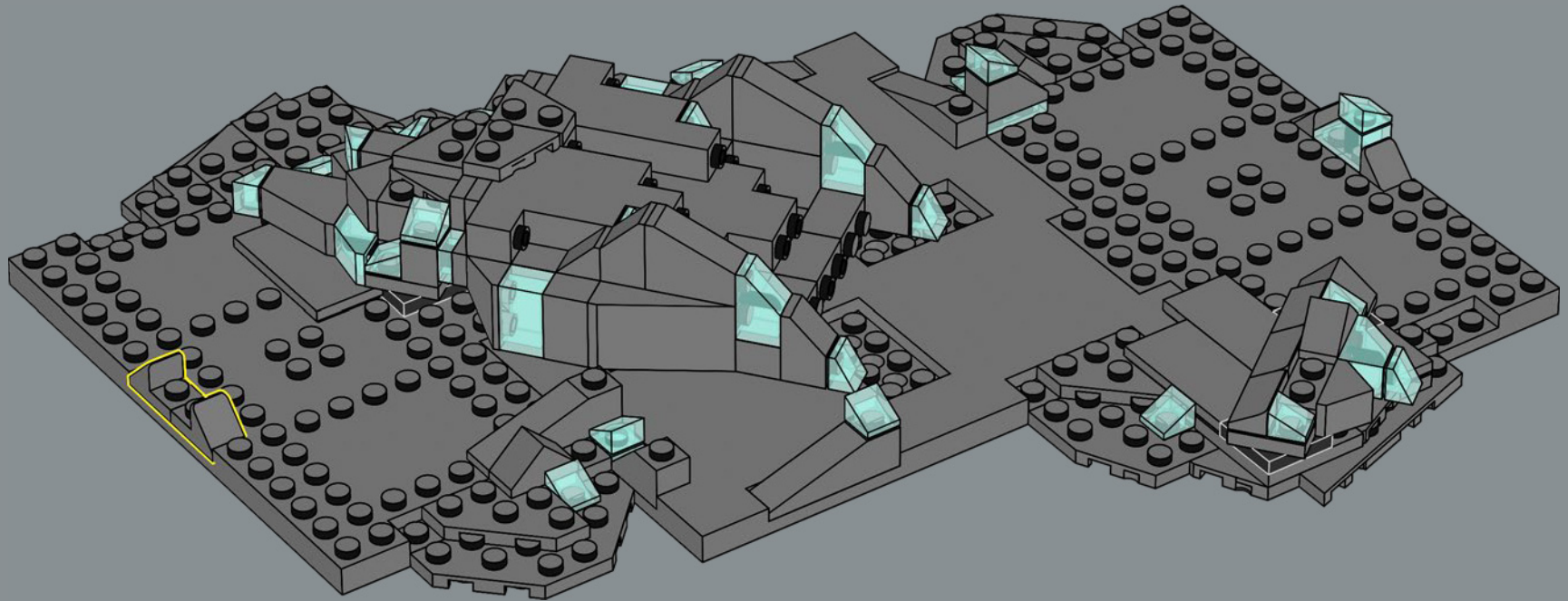

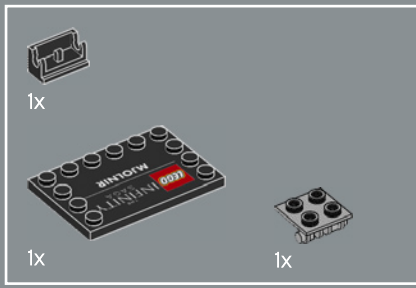

171

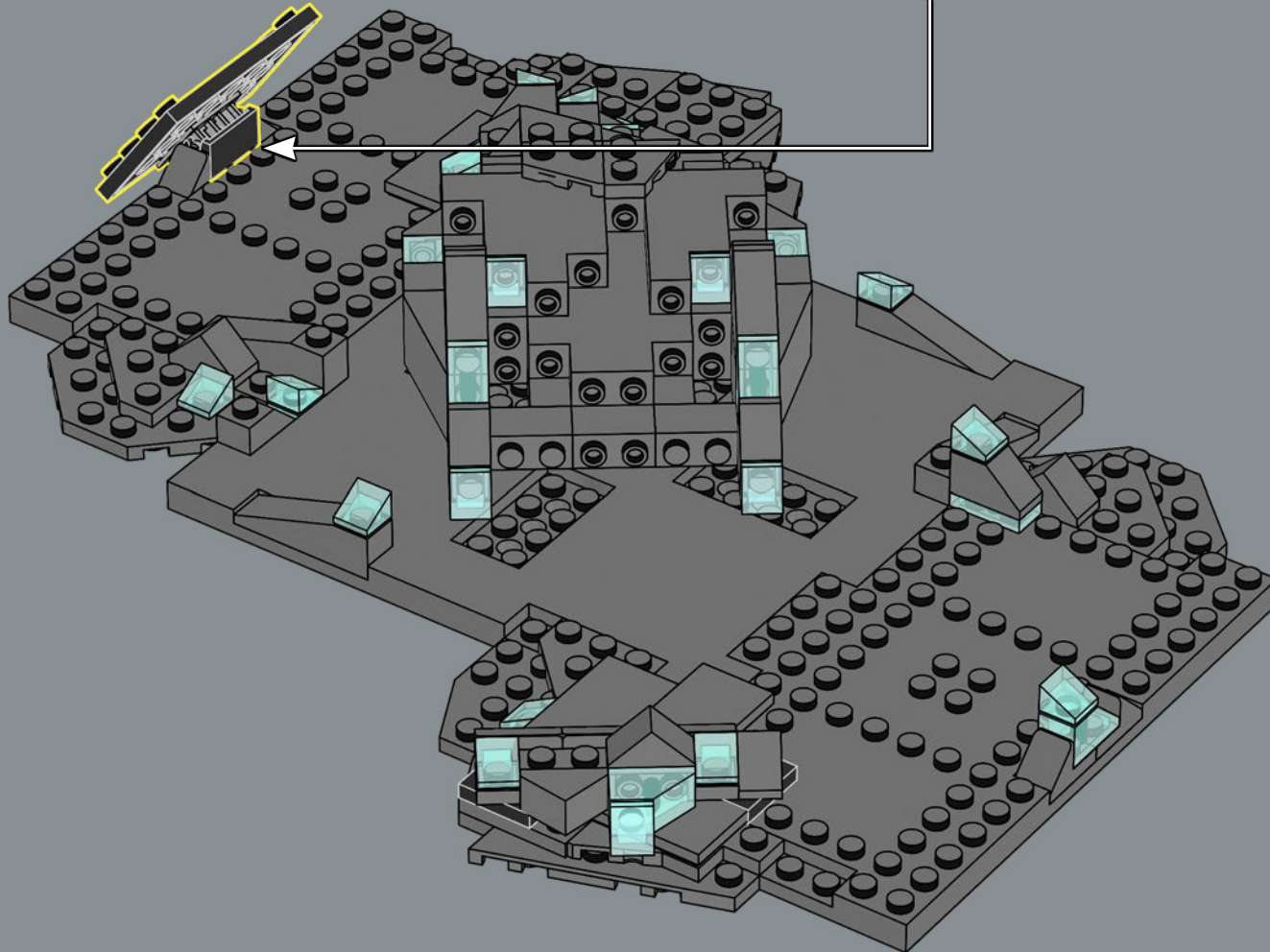
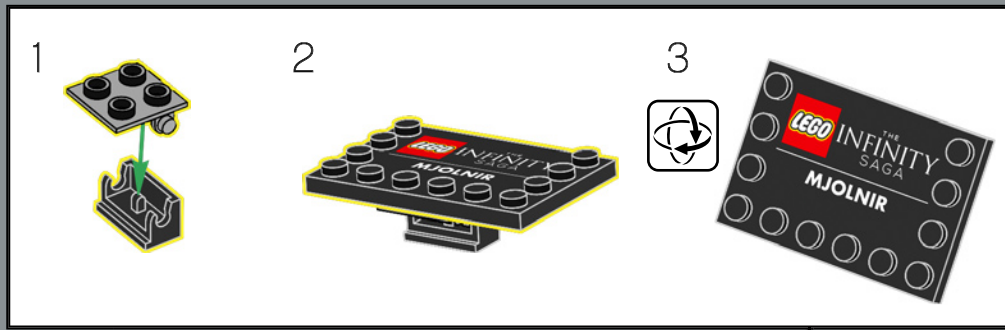





FEEDBACK AND WIN



FEEDBACK AND WIN

Your feedback will help shape the future development of this product series.

Please visit:

FEEDBACK UND GEWINNEN

Dein Feedback trägt zur Weiterentwicklung dieser Produktreihe bei.

Geh auf:

COMMENTEZ ET GAGNEZ

Vos commentaires nous aideront à concevoir les futurs produits de cette gamme.

Rendez-vous sur :

COMENTA Y GANA

Tu opinión nos ayudará a dar forma al desarrollo de esta serie de productos en el futuro.

Visita:

反馈有奖

您的反馈将有助于我们在今后改进本系列产品。

请访问：

[LEGO.com/productfeedback](https://www.lego.com/productfeedback)

By completing, you will automatically enter a drawing to win a LEGO® set.

Terms & Conditions apply.

Durch Ausfüllen nimmst du automatisch an der Verlosung eines LEGO® Preises teil.

Es gelten die Teilnahmebedingungen.

En envoyant vos commentaires, vous serez automatiquement inscrit(e) à un tirage au sort qui vous permettra de remporter un prix LEGO®.

Offre soumise à conditions.

Al contestar, participarás automáticamente en el sorteo y podrás ganar un set LEGO®.

Sujeto a Términos y Condiciones.

完成我们的反馈调查，即可自动进入抽奖环节，赢取乐高®套装。

适用《条款和条件》。



8x
4113261



30x
6097637



8x
428701



4x
6168618



4x
389401

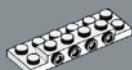

8x
4560929



2x
303401



8x
4579260



1x
6294704



23x
4114084



4x
4114077



8x
6132769



2x
4113993

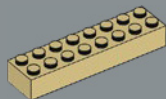

4x
6037398



4x
4651524



4x
303921



4x
370121



1x
6305110



2x
383221



14x
300423



1x
6186675



48x
6279875



1x
9339



1x
393726



8x
6138173



4x
368026



31x
300326



1x
6395354

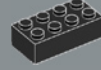

16x
300126



8x
4160025



1x
6376667



1x
6317515



1x
6221209



8x
6238677



14x
6240225



22x
6245277



2x
6252043



6x
6373578



1x
6351673



2x
6244910



2x
6240222



1x
6223000



1x
6294243



1x
6222339



1x
4255413



1x
6144754



1x
4505985



4x
6389696



1x
6314353



1x
6223003



112x
4658005



2x
4211399



2x
4211389



8x
6267495



2x
4211475



1x
4211512



4x
4540203



20x
6213378



4x
4211388



4x
4211398



8x
4211414



4x
4211564



26x
6117967



16x
4654580



1x
6004729



4x
6217876



1x
4667578



8x
4211413



16x
6212077



Customer Service
Kundenservice
Service Consommateurs
Servicio Al Consumidor

LEGO.com/service or dial



00800 5346 5555 :

1-800-422-5346 :





1x
4211881



8x
4211410



1x
4211815



8x
6251044



4x
4558169



4x
4211773



4x
4507056



6x
4211396



4x
4180418



1x
4211445



8x
4211394



44x
4622803



20x
6059033



3x
4515351



4x
4180408



44x
4509915



2x
6186338



1x
6015349



8x
6318584



2x
4211481



4x
4509914



18x
6014617



8x
4617862



8x
4211522

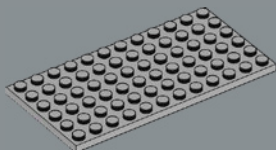

8x
4211400

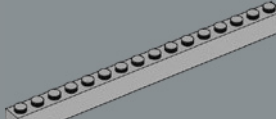

8x
4211366

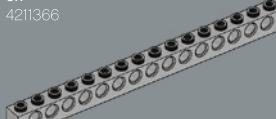

20x
4211443



8x
6271752



5x
6143417



5x
6143423



7x
4226221



3x
4567887



4x
4211096



4x
6069164



3x
6013658



4x
4211135



2x
4290150



2x
4210862



8x
4211000



4x
4210635



2x
6000853



3x
4211109



8x
4211107



2x
4211104



20x
6118832



19x
4210725



4x
4210725



2x
6039176



4x
4210897



6x
4560184



2x
4210984



3x
6401210



2x
4521572



1x
4216709



8x
4211107



1x
4211061



4x
4535930



2x
6039176

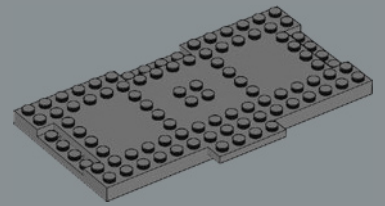

2x
6112762

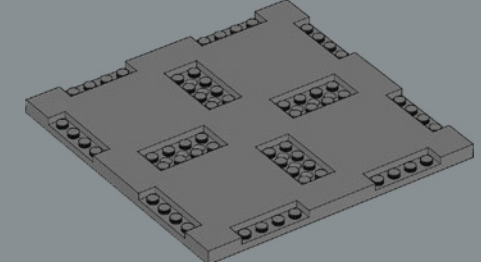

1x
6325635



1x
6350081



3x
6347982



1x
6376572



1x
6223006



1x
6223006



1x
6223006



1x
6223006



1x
6223006



1x
6223006

3

